

GSI 39™



USER MANUAL



Part Number D-0121780 Rev. C

Setting The Clinical Standard

www.grason-stadler.com

Grason-Stadler, 10395 West 70th Street, Eden Prairie, MN, USA 55344
800-700-2282 • 952-278-4402 • fax 952-278-4401 • e-mail info@grason-stadler.com

 **gsi**
Grason-Stadler

Title: GSI 39 Auto Tympanometer User Manual

Manufacturer

Grason-Stadler, Inc.
10395 West 70th Street
Eden Prairie, MN 55344
USA

Copyright © 2019 Grason-Stadler

All rights reserved. No part of this publication may be reproduced or transmitted in any form or by any means without the prior written permission of Grason-Stadler. The information in this publication is proprietary to Grason-Stadler.

Compliance

The CE 0123 mark identifies compliance with the Medical Device Directive 93/42/EEC. Grason-Stadler is an ISO 13485 certified corporation.

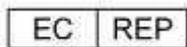

European Authority Representative
Grason-Stadler
c/o DGS Diagnostics A/S
Audiometer Alle 1
5500 Middelfart
Denmark



0123

Caution: US Federal law restricts this device to sale by or on the order of a physician or licensed hearing care professional.

TABLE OF CONTENTS

TABLE OF CONTENTS.....	3
Preface	9
Safety Summary	9
Warning.....	9
Caution.....	9
Notes.....	9
Safety Notes.....	9
Warning: Service Symbol	10
Customer Responsibility	10
Regulatory Symbols	12
Device Symbols	14
Safety Precautions	15
Cautions - General.....	15
Cautions – Warm Elements.....	16
Warning – Connection Additional Equipment	16
Warning – Electric Shock Hazards.....	16
Warning – Explosion	16
Warning – Connections.....	16
Warning – General.....	16
Warning – Voltage / Current Detectors	17
Recycling / Disposal	17
Warranty and Repair.....	18
Indications for Use	19
Introduction	19
Tympanometry and Gradient.....	21
Gradient	22
Screening Acoustic Reflex	22
Screening Audiometry	24
Unpacking and Inspection.....	25
Standard Components - General	25
Combo Probe -related Components	26
Optional Accessories.....	26
GSI 39 Initial Set Up.....	27

Components.....	28
Display and Printer.....	28
Probe (226 Hz).....	28
Combo Probe (226Hz and 1kHz)	28
Rear Panel Labels and Connectors.....	29
Bottom Panel	29
Loading the Paper	30
Paper Storage.....	30
Operation.....	31
226 Hz Probe Indicators	31
Combo Probe Indicators (226 Hz and 1000 Hz Probe Tone)	32
Preparing the Probe Assembly.....	32
Front Panel Controls and Indicators	34
Individual display Formats	37
226 Hz Tympanometry Screen.....	37
226 Hz Tympanometry/Reflex Screen	37
1000 Hz Tympanometry Screen.....	38
1000 Hz Tympanometry/Reflex Screen	38
Audiometry Screen	39
Tympanometry Testing Information.....	40
Obtaining a Seal	40
Combo Probe Insertion.....	42
Audiometry Testing (Version 3 and Version 4).....	43
Instructing the Patient	43
Placement of Earphones	43
Placement of Insert Phones.....	44
Response Handswitch (Optional Accessory).....	44
Tympanometry/Reflex Test Sequence.....	45
Tympanometry Only Mode.....	45
Tympanometry and Ipsilateral Reflex.....	47
Temporary Programming of Ipsilateral acoustic Reflex Test Frequencies	48
Tympanometry and Contralateral Reflex (Version 2 and Version 3).....	49
Tympanometry and Ipsilateral/Contralateral Reflexes (Version 2 and Version 3).....	51
Ipsilateral and Contralateral Acoustic Reflex testing	51
Exit tympanometry/reflex.....	52

Audiometry Sequence (Version 3 and Version 4).....	53
To enter the Audiometry mode	53
Transducer Selection.....	53
To change the frequency	53
To change the intensity level of the test tone	54
Screening audiometry.....	55
Audiometric Threshold	55
Manual Threshold Audiometry	55
Automatic Hearing Level.....	56
Theory of Operation.....	56
Performing the Auto HL Procedure	57
Exit audiometry.....	57
Tests in memory.....	57
Page mode	58
Memory erase.....	58
Printing test results.....	58
Program Mode	59
Program Mode	59
Program Mode Menu Items	59
Program Menu Page 1 Option Descriptions	60
PROBE HZ	60
TYMP OPTIONS	60
NORMAL BOX ASHA/NORMAL BOX OFF.....	60
NEWBORN NRM ON 1k / NEWBORN NRM OFF 1k.....	61
50th PERCNT ON 1k / 50thPERCNT OFF 1k	61
BASELINE ON 1k / BASELINE OFF 1k	61
AUTOSTART ON 1k / AUTOSTART OFF 1k.....	61
Reflex Display.....	62
Reflex dB HL plus curve.....	62
Reflex dB HL only	62
Reflex yes/no.....	63
226 Hz Reflex.....	63
1000 Hz Reflex.....	63
Auto HL Setup	64

Programming the Auto HL Procedure	64
Test Frequencies (Hz).....	64
Intensity Range (dB Hz).....	64
Start Test Ear.....	65
Scoring Rule.....	65
Tone Format.....	65
Language	66
Aud Range Normal/Aud Range Narrow	66
Print - Audiogram/Print – Aud Table	67
DEF XDUCER DD45 / DEF XDUCER INSERT	67
Program Menu Page 2 option descriptions	68
Data Xfer Config	68
Power Up Settings.....	68
PRN Header GSI/PRN Header Off/PRN Header Custom	69
Internal Printer / External Printer	69
RESET TO DEFAULTS.....	70
Exiting the program mode	70
Routine Maintenance	71
Pretest Tymp Checks.....	71
Calibration Quick Check for 226 Hz.....	72
Calibration Quick Check for Combo Probe	73
Altitude Adjustment.....	74
Pre-Test Audiometric Checks (Version 3 and 4 only).....	76
Noise recovery period.....	76
Elimination of ambient noise	76
Biological Check	77
Preventive Maintenance.....	78
Cleaning the system.....	78
Cleaning and Disinfecting Agents.....	78
Cleaning patient contact reusable devices.....	79
Probe Care – 226 Hz Probe	80
Probe nose cone cleaning	80
The O-Ring.....	81
The probe wire.....	81
Probe reassembly.....	82

Probe Care - Combo Probe Tip.....	83
Earphone Care (Versions 3 and 4 only).....	85
Paper supply.....	86
Test Results	87
Ear canal Volume – 226 Hz Probe Tone.....	87
Normal	87
Abnormal	87
Compliance Peak.....	88
Normal	88
Abnormal	88
Pressure Peak.....	89
Normal	89
Abnormal	89
Gradient	89
Normal	89
Abnormal	89
Acoustic reflex.....	90
Normal	90
Abnormal	90
Audiometry	90
Normal	90
Abnormal	90
Special Messages and Error Codes	91
Sample Test Results	92
Computer Interface.....	95
Introduction	95
Operation	95
Transferring during normal operation.....	95
Transferring from memory pages	95
Other LCD screen messages.....	95
INVALID SELECTION.....	95
NO DATA AVAILABLE.....	96
NOT AVAILABLE.....	96
Data Transfer Program Mode	96
Computer Interface.....	97

Interface configuration.....	97
Cable connections.....	97
GSI Suite.....	97
GSI Suite Interface configuration.....	97
Uploading data from the GSI 39 to GSI Suite.....	98
Appendix A - Technical Data	99
Standards	99
Protective Classification.....	99
Appendix B: Specifications.....	100
Tymanometry Modes.....	100
Pneumatic System	100
Acoustic Reflex Stimuli.....	101
Probe LED Indicators.....	102
Audiometry mode (Versions 3 and 4 only)	102
Transducers.....	102
Intensity Levels	103
Tone Format	103
Printer	103
Power	104
Environmental.....	104
Mechanical - Instrument.....	104
Appendix C: Glossary of Terms	105
Appendix D: Bibliography.....	106
Appendix E: Electromagnetic Compatibility (EMC).....	107
Cautions regarding EMC	107
Guidance and manufacturer’s declaration Electromagnetic emissions	108
Recommended separation distances between portable and mobile RF communications equipment	109
Guidance and Manufacturer’s Declaration Electromagnetic Immunity	110

PREFACE



READ THIS ENTIRE MANUAL BEFORE ATTEMPTING TO USE THIS SYSTEM!

Safety Summary

In this manual, two symbols identify potentially dangerous or destructive conditions and procedures.

WARNING



The WARNING symbol identifies conditions or practices that may present danger to the patient and/or user

CAUTION



The CAUTION symbol identifies conditions or practices that could result in damage to the equipment.

NOTES

NOTE: Notes help you identify areas of possible confusion and avoid potential problems during system operation

Safety Notes



WARNING The GSI 39 is designed for compliance to IEC and UL 60601-1 when used in the patient vicinity. To achieve this compliance, the GSI 39 is equipped with a specific power transformer (ref: 8511988), which should not be interchanged with any other transformer or supply.

Any program aimed at obtaining reliable records of hearing thresholds should be staffed and supervised by appropriately-trained individuals.

Latex is not used anywhere in the manufacturing process.

The base material for the earphone cushions is made from natural and synthetic rubber.

The material used to manufacture GSI's eartips is Krayton Thermoplastic Rubber.

Warning: Service Symbol

WARNING



The ▼ indicates the location of a service adjustment part and is intended for service personnel only. The GSI 39 is a specifically calibrated audiometer and Tympanometer, and the periodic service and adjustments for the instrument that may be required should be done only by an authorized GSI service technician.

Please read the entire manual prior to using the GSI 39 to become familiar with the test functions and proper accessory connections.

Accessory equipment connected to the analog and digital interfaces must be certified to the respective IEC standards (IEC950 for data processing or IEC 60601-1 for medical equipment). Furthermore, all configurations shall comply with the system standard IEC 60601-1-1. Everyone who connects additional equipment to the signal input or signal output port configures a medical system and is therefore responsible that the system complies with the requirements of the system standard IEC60601-1-1. If in doubt, consult the technical service department or a local GSI representative.

Customer Responsibility

WARNING



This product and its components will perform reliably only when operated and maintained in accordance with the instructions contained in this manual, accompanying labels, and/or inserts. A defective product should not be used. Parts which may be broken or missing or are plainly worn, distorted or contaminated should be replaced immediately with clean, genuine replacement parts manufactured by or available from GSI.

The responsibility of GSI for a malfunction product is limited by the warranty set forth in this manual. Should repair or replacement of this product become necessary after the warranty period, the customer should seek advice from GSI Technical Support prior to such repair or replacement. If this product is in need of repair, it should not be used until all repairs have been made and the unit is functioning properly and ready for use. The owner of this product has sole responsibility for any malfunction resulting from improper use or maintenance, or repair by anyone other than GSI, and from any malfunction caused by parts that are damaged or modified by anyone other than GSI.

This product should not be used in the presence of fluid that can come into contact with any of the electronic components or wiring. Should the user suspect fluids have contacted the system components or accessories, the unit should not be used until deemed safe by a GSI certified service technician.

Do NOT use in the presence of flammable gaseous mixtures. Users should consider the possibility of explosions or fire when using this device in close proximity to flammable anesthetic gases.

Periodically, have a service technician perform electrical safety checks on the unit in order to show continued compliance to IEC and UL 60601-1.

Regulatory Symbols

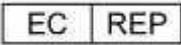
Symbol	Description
	Conforms to European Medical Device Directive 93/42/EEC.
	Symbol for "SERIAL NUMBER."
	GSI Part Number.
	Return to Authorized Representative, Special disposal required.
	Medical Equipment Classified by Intertek Testing Services NA Inc. with respect to electric shock, fire, and mechanical hazards only, in accordance with UL 60601-1. Classified under the Medical Device Directive (93/42/EEC) as a Class IIa device.
	Symbol for "European Representative."
	Symbol for "Manufacturer."
	Symbol for "Date of Manufacture."
	China RoHS symbol for products with a 50 year life cycle.
	Type B Equipment
	Consult the operating instructions/directions for use. A copy of the operating manual is available on this website: www.grason-stadler.com A printed copy of the operating instructions can be ordered from Grason-Stadler for shipment within 7 days; or you can contact your local representative.

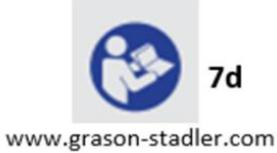
Symbol	Description
	<p>Consult the operating instructions/directions for use.</p> <p>A copy of the operating manual is available on this website: www.grason-stadler.com</p> <p>A printed copy of the operating instructions can be ordered from Grason-Stadler for shipment within 7 days; or you can contact your local representative.</p>

Device Symbols

The following symbols appear on the instrument

Symbol	Description
	Type B Equipment
	Attention, Consult Accompanying Documents
	Stand-By Switch
	DC Power
	Patient Response Handswitch
	Left Ear
	Right Ear
	Printer Connector
	Computer Connector
	USB Type Connectors
REF UES24LCP- 070300SPA	Power Supply Part Number

SAFETY PRECAUTIONS

WARNING



The following safety precautions must be observed at all times. General Safety precautions must be followed when operating electrical equipment. Failure to observe these precautions could result in damage to the equipment and injury to the operator or patient.

The employer should instruct each employee in the recognition and avoidance of unsafe conditions and the regulations applicable to his or her work environment to control or eliminate any hazards or other exposure to illness or injury.

It is understood that safety rules within individual organizations vary. If a conflict exists between the material contained in this manual and the rules of the organization using this instrument, the more stringent rules should take precedence.

This device should only be used by hearing health care professionals such as an audiologist, otolaryngologist, researcher or a technician under the direct supervision by the fore mentioned specialist. User should use their professional skills when interpreting the results and this should be done in conjunction with other testing as deemed appropriate given their professional skills.

The maximum sound levels that can be generated by the system can cause serious injury to the ear. Before attaching the earphones to the patient, ensure that:

- a. The system is running.
- b. The hearing levels in the test set to be used are appropriate.
- c. A biologic check of the stimulus has been performed by the operator.

The customer is responsible for maintaining all system software in a safe, secure location.

ANY EQUIPMENT CONNECTED TO THE GSI INSTRUMENT AND USED IN THE PATIENT VICINITY MUST BE POWERED BY AN ISOLATED POWER SOURCE TO MAINTAIN THE ELECTRICAL SAFETY OF THE OVERALL SYSTEM. The isolated power source can be purchased directly from GSI, or elsewhere when approved for use by GSI.

CAUTIONS - GENERAL

If the system is not functioning properly, do not operate it until all necessary repairs are made and the unit is test and calibrated for proper functioning in accordance with Grason-Stadler published specifications. Equipment is not user repairable. Repairs and battery replacement must be performed by a qualified service representative only.

CAUTIONS – WARM ELEMENTS

In conditions at the high limit of the operating temperature (40 degrees), certain parts of the probe, and the event switch may reach a temperature of 46 degrees Celsius. Incidental contact of these parts with the patient should be avoided and must be limited in duration to less than 10 minutes.

WARNING – CONNECTION ADDITIONAL EQUIPMENT

Accessory equipment connected to the analog and digital interfaces must be certified to the respective IEC standards (IEC 950 for data processing or IEC 60601-1 for medical equipment and/or appropriate European Directives). Furthermore, all configurations shall comply with the system standard IEC 60601-1-1. Everyone who connects additional equipment to the signal input or signal output port configures a medical system, and is therefore responsible for the system compliance with the requirements of the system standard IEC 60601-1-1. If in doubt, consult the technical service department or your local representative. Connect all nonmedical equipment to the GSI Isolated Power Supply.

The AC power outlets on the isolation transformer/power box are intended for use with GSI approved components only. Use of any other equipment may result in damage to the power unit. Follow all safety standards set by each place of employment.

NOTE: If the Instrument is connected to a PC, power to the monitor and computer must be controlled by the isolation transformer. Always leave the monitor and computer power switches in the ON position and control power from the isolation transformer. Always turn OFF system power before connecting or disconnecting system components to help guard against personal injury.

WARNING – ELECTRIC SHOCK HAZARDS

Do not open the case of the GSI instrument. Do not remove any GSI instrument covers. Refer servicing to qualified personnel.

WARNING – EXPLOSION

This system is not explosion proof. Do not use in the presence of flammable anesthetics or other gases.

WARNING – CONNECTIONS

Do not switch on any system power until all cables have been properly connected and verified. See this manual for setup instructions, which accompanies all deliveries of the system. Switch off the system power before connecting or disconnecting any system component(s) or accessories. This may damage the device(s).

WARNING – GENERAL

Proper use of this device depends on careful reading of all instructions and labels. Follow all safety standards set by each place of employment.

WARNING – VOLTAGE / CURRENT DETECTORS

If voltage or current detectors are tripped the outputs will be muted.

Recycling / Disposal



Many local laws and regulations require special procedures to recycle or dispose of electrical equipment and related waste including batteries, printed circuit boards, electronic components, wiring and other elements of electronic devices. Follow all local laws and regulations for the proper disposal of batteries and any other parts of this system.

Below is the contact address for proper return or disposal of electronic wastes relating to Grason-Stadler products in Europe and other localities. The contact information for the WEEE in Europe:

Grason-Stadler
c/o DGS Diagnostics A/S
Audiometer Alle 1
5500 Middelfart
Denmark

WARRANTY AND REPAIR

We, Grason-Stadler, warrant that this product is free from defects in material and workmanship and, when properly installed and used, will perform in accordance with applicable specifications. This warranty is extended to the original purchaser of the instrument by GSI through the distributor from whom it was purchased and covers defects in material and workmanship for a period of one year from date of delivery of the instrument to the original purchaser. If within one year after original shipment, it is found not to meet this standard; it will be repaired, or at our option, replaced at no charge except for transportation costs, when returned to an authorized Grason-Stadler facility. If field service is requested, there will be no charge for labor or material; however, there will be a charge for travel expense at the service center's current rate.

NOTE: Opening the instrument case or changes to the product not approved in writing by Grason-Stadler shall void this warranty. Grason-Stadler shall not be responsible for any indirect, special or consequential damages, even if notice has been given in advance of the possibility of such damages. The transducers may go out of calibration due to rough handling or impact (dropping). The lifetime of probe, probe seals and eartips is dependent upon conditions of use. These parts are only guaranteed against faulty materials or manufacture.

THIS WARRANTY IS IN LIEU OF ALL OTHER WARRANTIES, EXPRESSED OR IMPLIED, INCLUDING BUT NOT LIMITED TO, ANY IMPLIED WARRANTY OF MERCHANTABILITY OR FITNESS FOR A PARTICULAR PURPOSE.

We advise you against attempting to rectify any faults by yourself or commissioning non-experts to do so. Equipment is not user repairable. Repairs must be performed by an authorized service representative only.

WARNING



No modifications of the equipment are allowed by anyone other than a qualified GSI representative. Modification of the equipment could be hazardous. If this equipment is modified, appropriate inspection and testing must be conducted to ensure continued safe use of the equipment.

In order to ensure that your instrument works properly, the GSI GSI 39 should be checked and calibrated at least once per year. This check must be carried out by your dealer or authorized GSI service facility.

When returning the instrument for repairs or calibration it is essential to send the acoustic transducers with the device. Send the device to an authorized service center only. Please include a detailed description of faults. In order to prevent damage in transit, please use the original packing if possible when returning the instrument.

INDICATIONS FOR USE

The GSI 39 is an audiometric screening product that offers basic pure tone audiometry and tympanometry with reflex. The GSI 39 is available with both 226Hz and 1Khz probe tones to accommodate testing for patients between the ages of birth through geriatric. The instrument is to be used by trained personnel only, such as audiologists, ENT surgeons, physicians, hearing healthcare professionals or personnel with a similar level of education. This device should not be used without necessary knowledge and training to understand its use and how results should be interpreted.

Introduction

The **GSI 39 Auto Tymp** (hereafter referred to as '**instrument**' in this guide unless otherwise noted for clarity) is a versatile combination instrument that provides testing capability for tympanometry alone, tympanometry combined with screening acoustic reflex measurements, and screening audiometry.

Five different versions are available to meet individual testing needs.

- Version 1 - tympanometry alone and tympanometry plus screening ipsilateral acoustic reflex testing.
- Version 2 - tympanometry alone and tympanometry plus ipsilateral and contralateral screening acoustic reflex measurements.
- Version 3 - tympanometry alone, tympanometry plus ipsilateral and contralateral screening acoustic reflex measurements, and screening audiometry, both manual and automated.
- Version 4 - tympanometry alone, tympanometry plus ipsilateral acoustic reflex screening testing, and screening audiometry, both manual and automated.
- Version 5 - tympanometry only.

It is possible to upgrade versions 1, 2, 4 and 5 with the full functionality provided with version 3 after the time of original purchase.

Each version can be ordered with the Combo Probe that allows for both 226 Hz and 1000 Hz probe tone. 1000 Hz probe tone is recommended for testing on infants 0 - 6 months of age.

An optional soft-sided carrying case is available for portability. Also, a patient handswitch, patch cords, and earphone sound enclosures may be purchased as optional accessories.

WARNING



The GSI 39 is designed to be used with a hospital grade outlet. Injury to personnel or damage to equipment can result when a three-prong to two-prong adapter is connected between the GSI 39 power plug and an AC outlet or extension cord.

Additionally, the GSI 39 is equipped with a specific power transformer (8511988), which should not be interchanged with any other transformer or supply. The GSI 39 is a specifically calibrated device and the periodic service and adjustments, which the instrument may require, should be done only by

an authorized GSI service technician.

CAUTION



The GSI 39 is designed to comply with the EMC requirements according to IEC 60601 1-2. Radio transmitting equipment, cellular phones, etc. should not be used in the close proximity of the device since this could influence the performance of the device.

Particular caution must be considered during use of strong emission sources such as high frequency surgical equipment and similar devices. If in doubt, contact a qualified technician or a local GSI representative.

Tympanometry and Gradient

Tympanometry provides an objective means for determining the amount of mobility present within the eardrum and the ossicular chain. It is, however, important to keep in mind the fact that the amount of mobility present within the ossicular chain may be camouflaged by a scarred or thickened eardrum.

Acoustic energy, commonly referred to as the probe tone (226 Hz or 1000 Hz) is introduced into a hermetically sealed ear canal by means of a loudspeaker located within the probe. The intensity of this tone is monitored via a microphone, also located within the probe box. Measurements are taken at fixed time intervals.

As pressure within the ear canal is varied, the eardrum is subjected to varying degrees of stress which alters the mobility of the eardrum. Maximum mobility will occur when the pressure on both sides of the eardrum are equal. Changes in mobility of the eardrum tend to produce changes in the probe tone level within the ear canal. Probe tone intensity changes indicate the amount of sound energy entering the middle ear.

Compliance is calculated based on these measurements. Since the sound pressure level of the probe tone within the ear canal varies as a function of mobility, it is possible to record these changes in mobility as a function of pressure. While the recording is visualized in the horizontal direction (X-axis) as a function of differential pressure across the eardrum, the tracing also moves in the vertical direction (Y-axis) as a function of mobility or admittance of the middle ear system. A graphic presentation of this information is known as a tympanogram

The point of the tympanogram which represents the point of maximum compliance is the compliance peak of the tympanogram. The air pressure (pressure at the peak) where this compliance peak occurs approximates the pressure within the middle-ear system, since maximum mobility is only possible when there is little or no pressure difference between the ear canal and the middle-ear space. Compliance using a 226 Hz probe tone is measured with respect to the ability of an equivalent volume of air to conduct sound and the scientific quantity used is cm^3 . Compliance using the 1000 Hz probe tone is measured in mmhos as it is not an ear canal compensated measurement. Air pressure is measured in deca Pascals (daPa).

NOTE: 1.02 mmho = 1.0 daPa

The presence of a pathological condition which interferes with the mobility of the tympanic membrane, the ossicular chain, or the air pressure within the middle-ear space can be detected during tympanometry.

- If the air pressure within the middle-ear space becomes negative due to a blocked Eustachian tube, tympanometry measures this negative pressure and its effect on middle-ear compliance.

- If fluid builds up within the middle-ear space, this fluid will restrict the ability of the ossicular chain to conduct sound to the cochlea. If small air pockets exist within the fluid, the tympanogram will indicate the negative pressure where the restricted mobility occurs. With a totally fluid-filled middle-ear space, no mobility will be measured during tympanometry at any pressure value.
- In the case of a “glue-ear”, the ossicular chain is restricted in mobility. This tympanogram would depict a flat line with no identifiable pressure peak.

Gradient

Gradient (width) measurements are used to describe the shape of a tympanogram near the peak. Often, the presence or absence of fluid in the middle ear is not clearly indicated by otoscopy and tympanometry alone. This evaluation is especially difficult when the peak pressure is within the normal range.

The presence of fluid within the middle-ear space alters the shape of a tympanogram (i.e., makes the tympanogram wider near its peak). A larger-than-normal gradient can indicate the presence of fluid in the middle ear when other parameters are within normal limits. In this way, the gradient acts as an adjunct to the tympanogram and ear canal volume measurements by helping to differentiate between tympanograms with similar peak values.

The instrument uses tympanometric width to determine the gradient by measuring the pressure interval at one-half of the tympanogram peak height. Differing tympanogram peak widths can point to different middle-ear conditions, even when peak height and pressure are within normal range. For example, middle-ear effusion caused by secretory otitis media many result in an increased tympanogram width and, therefore, an increased gradient value. This would occur because the ossicular chain cannot react to the change in pressure introduced during the tympanogram in the same way that it would if the middle ear were properly aerated. The continued presence of effusion, leading eventually to a completely fluid filled middle-ear cavity, will reduce the magnitude of the tympanogram to the point where no change in compliance is detectable across the pressure range. Under this condition, no gradient measurement is possible.

On the GSI 39, gradient measures are only calculated for the 226 Hz probe tone conditions.

Screening Acoustic Reflex

An acoustic reflex occurs when a very loud sound (stimulus) is presented to the auditory pathway. During acoustic reflex testing, the stimulus is presented to the ear canal through a probe (ipsilateral) or through an insert phone (contralateral). This stimulus then travels through the middle ear to the cochlea. From the cochlea, frequency and intensity information is transmitted via the 8th nerve to the brain stem where a determination is made as to whether or not the intensity of the stimulus is high enough to elicit a reflex response. If it is, a bilateral response occurs (i.e., the right and left 7th nerves innervate their respective middle-ear muscles (stapedial muscles) causing them to contract).

As these muscles contract, they stiffen their respective ossicular chains. This stiffening of the ossicular chain reduces the compliance of each middle-ear system.

When the stimulus is presented to the same ear as the measurement, the test is referred to as an ipsilateral (same side) acoustic reflex test. When the stimulus is presented to the opposite ear than the measurement, the test is referred to as a contralateral (opposite) acoustic reflex test.

During ipsilateral acoustic reflex testing, both the stimulus and the probe tone are presented via the hand-held probe. With contralateral testing, the stimulus is presented via an insert phone or earphone and the probe tone is presented via the hand-held probe. In both cases, the measurement is made from the ear where the probe is positioned. For 226 Hz probe tone reflex measurements, the air pressure within the ear canal where the probe is positioned is set to the pressure value measured at the point of maximum compliance for that ear during tympanometry with an offset of -20 daPa (or +20 daPa for a positive pressure peak).

For 1000 Hz probe tone reflex measurements, the system will measure the change in compliance at 0 daPa, regardless of peak pressure. When evaluating the absence of reflexes, you should note the peak pressure of the tympanogram. Decreased mobility at 0 daPa may contribute to the absence. Reflex testing should be repeated when the middle ear pressure has returned to 0 daPa.

Acoustic reflex measurements are useful to determine the integrity of the neuronal pathway involving the 8th nerve, brainstem, and the 7th nerve. Since the acoustic reflex test (ipsilateral or contralateral) is performed at high intensity levels and since it involves a measurement of middle-ear mobility, acoustic reflex testing is not a test of hearing.

The acoustic reflex also serves as a good validation of tympanometric results since an acoustic reflex cannot be measured in the absence of a compliance peak. In other words, if the tympanometric results indicate no mobility over the pressure range available, no reflex will be observed. If the test results indicate a reflex response in the absence of a compliance peak, one has cause to question the validity of the tympanometric test results. This indicates that the tympanogram should be repeated.

Clinical middle-ear instruments allow the measurement of the acoustic reflex threshold since they provide the ability to manually change the intensity of the stimulus to a level where a reflex response is just barely detectable for each patient tested. However, this screening instrument automatically presents the stimulus in a very definite stimulus intensity sequence. This preset intensity sequence may start at a level above an individual's acoustic reflex threshold level. Also, since the instrument uses a hand-held probe and noise from hand motion can be detected by the instruments circuitry, the magnitude of a detectable response must be somewhat higher than the criterion generally used during clinical acoustic reflex threshold testing to avoid artifact caused by hand motion. The acoustic reflex measurements made with this instrument are referred to as screening acoustic reflex testing. The purpose of these screening reflex tests is to determine whether a reflex is detectable rather than to determine the lowest intensity at which the reflex occurs (i.e., threshold testing).

Screening Audiometry

While tympanometry and acoustic reflex measurements check the integrity of the middle-ear system, audiometry provides a means for checking the integrity of the entire auditory pathway. Screening audiometry provides a method to determine an individual's ability to hear a test signal at a particular intensity level or at the lowest possible intensity level without the use of masking.

During screening audiometry, the test signal is generally presented through an earphone to the ear. Different screening test protocols define the frequencies and intensity sequence to be used to obtain a response. Audiometric testing requires a behavioral response from the individual being tested. This consists of having the individual raise a finger/hand or press a handswitch (optional) whenever the test signal is heard. The finger/hand is lowered or the handswitch is released when the test signal is no longer audible. The individual being tested must be able to understand a set of simple instructions and have the ability to provide some physical sign when the test signal is heard.

The GSI 39 allows for both manual and automated audiometry. For further details on automated audiometry, see *Automatic Hearing Level* in Chapter 3 of this guide.

UNPACKING AND INSPECTION

Examine the outside of the shipping container for any signs of damage. Notify the carrier immediately if any damage is noted.

Carefully remove the instrument from its shipping container. Remove the plastic bag protecting the instrument. If the instrument appears to have suffered mechanical damage, notify the carrier immediately so that a proper claim can be made. Be certain to save all packing material so that the claim adjuster can inspect it as well. As soon as the carrier has completed the inspection, notify a GSI Distributor.

Check that all accessories listed in Table 1 (per version ordered) are received in good condition. If any accessories are missing or damaged, notify a GSI Distributor or the factory immediately.

NOTE: Keep the original packing material and shipping container so the instrument can be well packaged if it needs to be returned to the local service center for repair or calibration.

WARNING



ONLY GSI approved parts and accessories should be used with this Instrument. The use of parts or materials that are not recognized to be used with this device can degrade minimum safety.

Standard Components - General

- Probe Assembly (226 Hz Probe or Combo Probe)*
- Audiometry Headset, DD45 (Version 3 and Version 4)*
- Contralateral Insert Phone (Version 2 and Version 3)*
- Insert Phone Ear Tips (8 sizes, 4 each) (Version 2 and Version 3)*
- Probe Eartips (6 sizes, 2 each)*
- Switching Power Adapter
- 2m USB Cable
- Test Cavity
- Operating Instructions (on USB drive)
- GSI Suite (on USB drive)
- Wall Chart, 226 Hz
- 4" Thermal Paper, 3 rolls

*Applied Parts according to IEC 60601-1

Combo Probe -related Components

- Combo Probe (226 Hz / 1kHz Version)*
- Audiometry Headset, DD45 (Version 3 and Version 4)*
- Contralateral Insert Phone (Version 2 and Version 3)*
- Insert Phone Ear Tips (8 sizes, 4 each) (Version 2 and Version 3)*
- Probe Eartips (6 sizes, 2 each)*
- Audiometry Headset, DD45 (Version 3 and Version 4)*
- Contralateral Insert Phone (Version 2 and Version 3)*
- Switching Power Adapter
- 2m USB Cable
- Test Cavity
- Operating Instructions (on USB drive)
- GSI Suite (on USB drive)
- Wall Chart, 226 Hz
- 4" Thermal Paper, 3 rolls
- Tubing Replacement Kit
- Probe Cleaning Kit, Floss
- Probe Mount, Wrist
- Probe Mount, Shoulder
- Wall Chart, 1kHz

Optional Accessories

- Dust Cover
- Carrying Case
- Patch Cord
- Subject Response Handswitch
- Audiocups Earphone Sound Enclosures
- Service Manual USB Bundle
- Insert Phone Assembly

*Applied parts according to IEC 60601-1

GSI 39 INITIAL SET UP

Place the instrument on a stable counter or table where it will be used. The location should be near a properly grounded wall outlet. Carefully attach purchased accessories to their appropriately labeled connector on the rear panel of the instrument.

Locate the **power** switch on the rear panel of the instrument and move the switch to the **On** position. When power is turned on, the light on the LCD will be illuminated and the orange light on the probe will be lit. The display on the LCD will display a scroll bar across the top to indicate the system is initializing.

The system will power up to the factory default test mode (to set user-defined power up setting, see *Program Mode* section) and the probe green lamp will begin to blink indicating that the instrument is ready to begin the testing. If both the green and yellow lamps are illuminated at the same time following power on, the probe is occluded or the tympanogram software did not initialize properly. Simply move the power switch to the off position, inspect the probe tip for any signs of an occlusion, and reposition the power switch to **On**. If both green and yellow lamps are still illuminated and the probe is not occluded, contact a local service representative or the GSI service department for repair. In the meantime, it is still possible to use the Audiometry mode (if purchased).

Allow the instrument to warm-up for about 10 minutes before conducting a test. This allows the electronic circuits to stabilize prior to use. If the storage temperature is lower than the room temperature, allow additional time for the instrument to reach room temperature.

CAUTION



Use only the GSI provided power supply. The GSI 39 provided power supply should only be connected to a power source meeting the following range 90-246VAC, 47-63Hz. In North America the power source should be a maximum of 120VAC.

Components

DISPLAY AND PRINTER

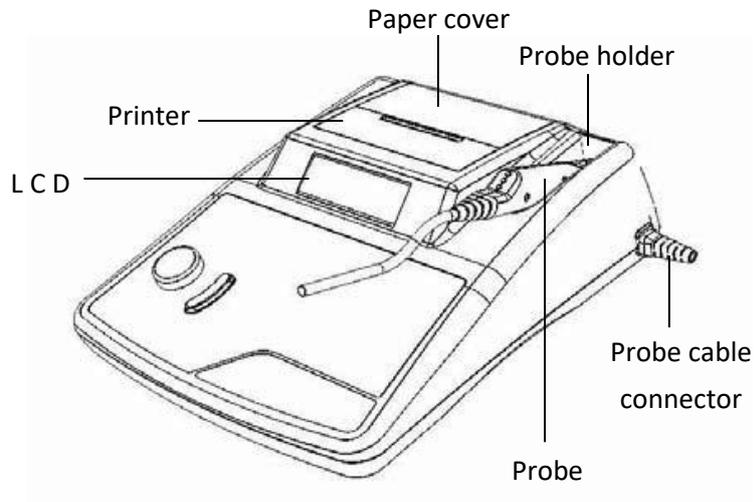

PROBE (226 HZ)

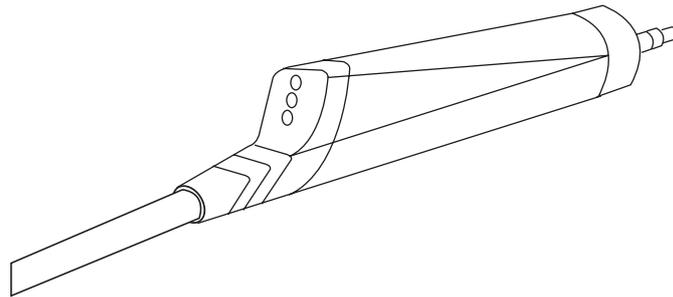

COMBO PROBE (226HZ AND 1KHZ)

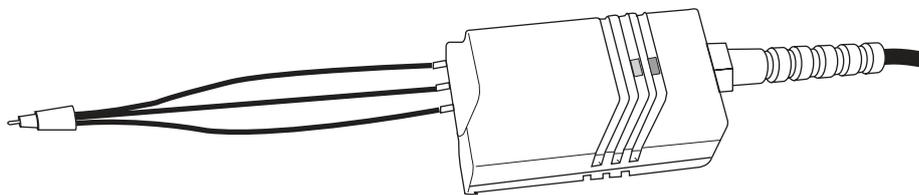

REAR PANEL LABELS AND CONNECTORS

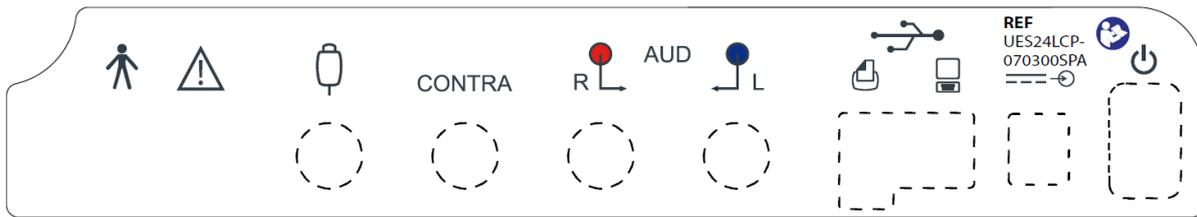

NOTE: See Device Symbols Section for detailed descriptions

WARNING



Accessory equipment connected to the analog and digital interfaces must be certified to the respective IEC standards (IEC 950 for data processing or IEC 60601-1 for medical equipment). Furthermore, all configurations shall comply with the system standard IEC 60601-1-1. Everyone who connects additional equipment to the signal input or signal output part configures a medical system, and is, therefore, responsible that the system complies with the requirements of the system standard IEC 60601-1-1. If in doubt, consult the technical service department or a local representative.

BOTTOM PANEL

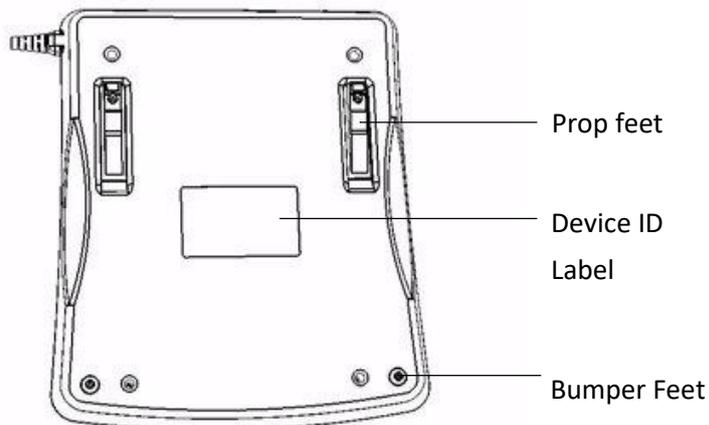

Loading the Paper

Remove the printer cover by placing fingers along the back edge of the printer and pulling upward on the cover. Cut the printer paper so that the leading edge of paper is straight across. Place the roll of paper inside the paper well so that the paper will unroll from the lower surface. See the paper loading label located on the side of the paper well.



Paper Well

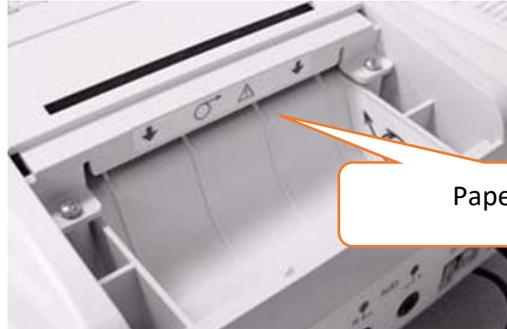

Paper Slot

Position the leading edge of the paper roll into the paper slot. Press the paper advance  button until a section of paper is long enough to pass through the printer cover.

PAPER STORAGE

The instrument is supplied with a thermal printer. This type of printer requires a heat-sensitive paper to create an image. For maximum paper life, any spare rolls of paper should be stored as follows:

- a. Store in the dark (i.e., in a drawer or cabinet)
- b. Do not store above 77° F (25° C)
- c. Store at less than 65% relative humidity

The above recommendations are for the maximum paper life (greater than five years). Storing thermal paper at high temperatures or high humidity levels will shorten the total paper life. The paper will show some darkening if stored for 24 hours at 113° F (45° degrees C) and a relative humidity of greater than 90%. Avoid leaving paper in a hot car or other hot area overnight. Always avoid storing unused paper or printed tests in a lighted area.

OPERATION

226 Hz Probe Indicators

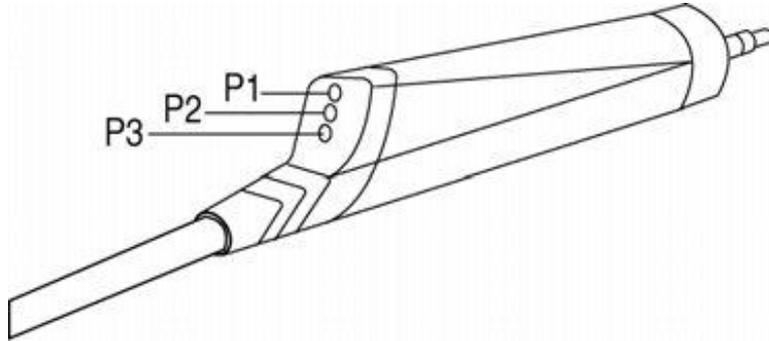

- P1 - Yellow:** The probe is occluded. Remove the probe and inspect for cause of occlusion.
- P2 - Green lamp:** *Blinking* - The instrument is ready to begin a Tympanometer test. *Steady green* - Test successfully started and in progress.
- P3 - Orange:** A pressure leak has been detected.

Combo Probe Indicators (226 Hz and 1000 Hz Probe Tone)

PREPARING THE PROBE ASSEMBLY

The ipsilateral probe tip and tubing are attached to the probe box at the factory. Connect the contralateral insert phone cable to the jack on the back of the base if contralateral reflex testing is required. If contralateral testing will not be performed on a regular basis, it is not necessary to keep the contralateral phone attached to the system at all times.

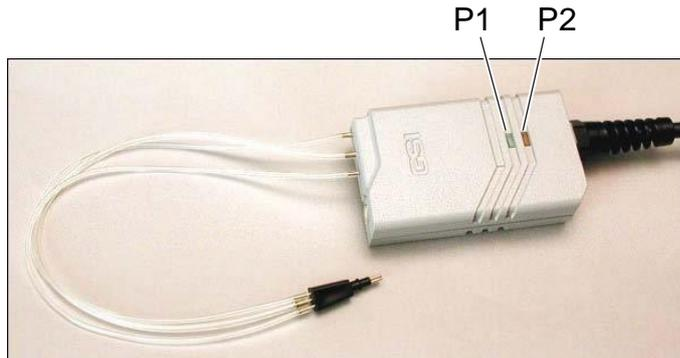

P1 - Green lamp: *Blinking green* - Ready to start test.

Steady green - Test in progress.

P2 - Orange: *Blinking orange* - Pressure leak.

Steady orange - Occlusion.

P1 and P2 off: Test is finished.

WARNING



Ensure that the Insert phone cable plug is inserted all the way into the jack for operation.

WARNING



To ensure the accuracy of calibration, the tygon tubing supplied with the ipsilateral probe assembly should not be cut or altered in any way. The system has been specifically calibrated to meet specifications with the tubing length supplied with this unit. A spare set of tubing is provided. If the replacement tubing supplied with the instrument is used, recalibration is unnecessary.

The small 8 mm ear tips for the 1000 Hz option are used when doing a 1000 Hz probe tone test, which is assumed to be on an infant. Validation testing of the GSI 39 performed on infants showed that the 8 mm size tip was the best probe for that purpose.

When doing a 226 Hz probe tone test, use the 8013174 White Flat tips. The 226 Hz probe tone test

auto starts the pressure sequence and placing the probe in the ear canal when the pressurization begins can result in unwanted deflections in the tympanogram. The White Flat ear tips allow the user to place the probe and hold the Probe Tip at the entrance to the patient's ear canal while the tympanogram and reflex testing are performed.

WARNING



A GSI provided Probe Tip must be used. Using the probe without the Probe Tip could result in injury to the subject.

WARNING



Ear tip needs to be attached before the phone is inserted.

Front Panel Controls and Indicators

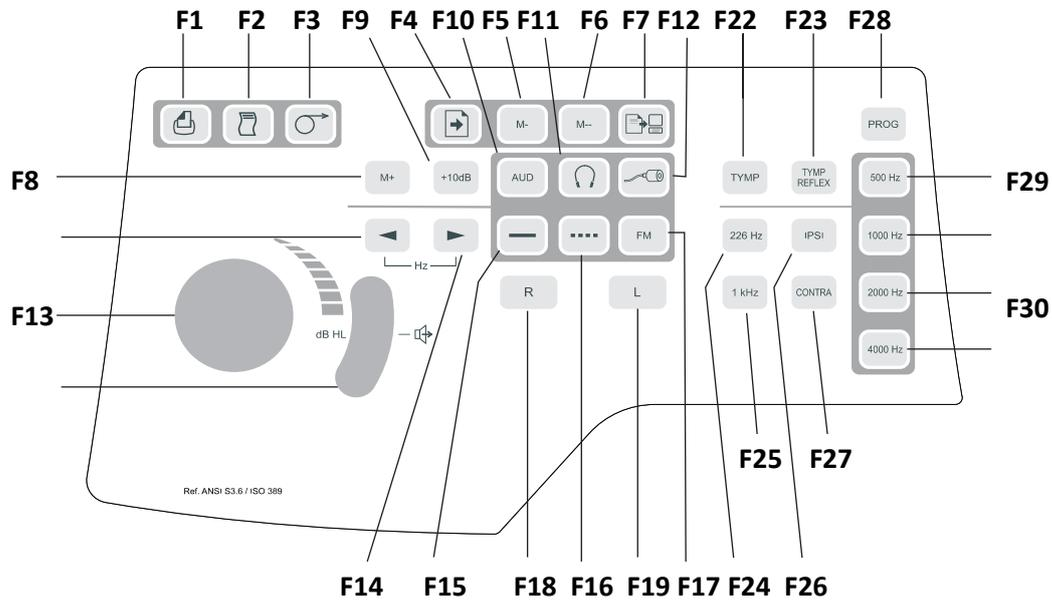

Legend / Label	Button	Description
F1 / Print Screen		Used to print the currently displayed page of memory or active test screen.
F2 / Print All Memory		Used to print all pages of data from memory.
F3 / Paper Advance		Causes paper to feed through printer; may be used to load paper or to provide space between printouts.
F4 / PAGE		Enters Page Mode: Pressing F13 and F14 scrolls through the test results stored in memory.
F5 / M -	M-	Erases currently displayed page of data from memory.
F6 / M - -	M--	Erases all pages of data from memory.
F7 / Data Transfer		Transfers test results to an attached computer.
F8 / M+	M+	Save button; during Audiometry mode, saves threshold information per frequency on the display; during Program mode, selects highlighted option.
F9 / +10 dB	+10dB	Used to temporarily extend the intensity range by 10 dB; a large + sign appears on the display indicating that the extended range has been selected.

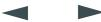
Legend / Label	Button	Description
F10 / Aud(iometry)	AUD	Selects Audiometry mode (Available in Version 3 & Version 4 only). When in Audiometry, this button starts the Auto HL when held for 3 seconds.
F11 / Headphone		Selects the DD45 calibration files for transducers. When the  button is pressed, the display will flash to ensure that the user wants to change the transducer selection. The  button must be pressed again to engage the DD45 headphone calibration file. The  symbol is shown on the center of the display if selected
F12 / Insert		Selects the insert earphone calibration file for transducers. When the  button is pressed, the display will flash to ensure that the user wants to change the transducer selection. The  button must be pressed again to engage the insert earphone calibration file. The symbol is shown on the center of the display if selected.
F13 and F14 / Decrease and Increase Frequency		Selecting  advances the presentation tone to the next lower frequency; selecting  advances the presentation tone to the next higher frequency.
F15 / Steady		Used during Audiometry mode to select a continuous test tone when Present Bar is depressed; the steady symbol appears on the display.
F16 / Pulsed		Used during Audiometry mode to select a pulsed tone when the Present Bar is depressed; the pulsed symbol appears on the display.
F17 / FM	FM	Used during Audiometry mode to select a frequency modulated test tone when the Present Bar is depressed; the letters FM appears on the display when selected.
F18 / R	R	Used to indicate the right ear is the ear data stored in memory and/or printed is properly identified as right. Versions 3 and 4, used to select right earphone for audiometry. An R will appear on the LCD.

Legend / Label	Button	Description
F19 / L		Used to indicate left ear is the test ear; so data stored in memory and/or printed is properly identified; for Versions 3 and 4, used to select left earphone for audiometry. An L will appear on the LCD.
F20 / AttenuatorKnob (dB HL)		Used to increase or decrease the intensity of the test tone presented in Audiometry mode; counterclockwise rotation decreases the intensity; clockwise rotation increases the intensity.
F21 / Present Bar		In Audiometry mode, used to present test signal to appropriate earphone; release to turn test tone off.
F22 / TYMP		Selects Tympanometry only mode.
F23 / Tymp Reflex		Selects Tympanometry and Reflex mode.
F24 / 226Hz		Selects 226 Hz for Probe Tone Frequency.
F25 / 1KHz		Selects 1000 Hz for Probe Tone Frequency.
F26 / IPSILATERAL		Selects an ipsilateral reflex test.
F27 / CONTRALATERAL		Selects a contralateral reflex test (available with Versions 2 and 3 only).
F28 / Prog(ram)		Selects Program mode screen which lists settings available for reflex presentation format, printout header format, audiogram vs. tabular format, display normal box, and identify frequency range for Audiometry mode.
F29 / 500		Selects 500 Hz as a stimulus during reflex testing.
F30 / 1000		Selects 1000 Hz as a stimulus during reflex testing. (Not available with 1000 Hz probe tone.)
F31 / 2000		Selects 2000 Hz as a stimulus during reflex testing.
F32 / 4000		Selects 4000 Hz as a stimulus during reflex testing.

INDIVIDUAL DISPLAY FORMATS

226 Hz Tympanometry Screen

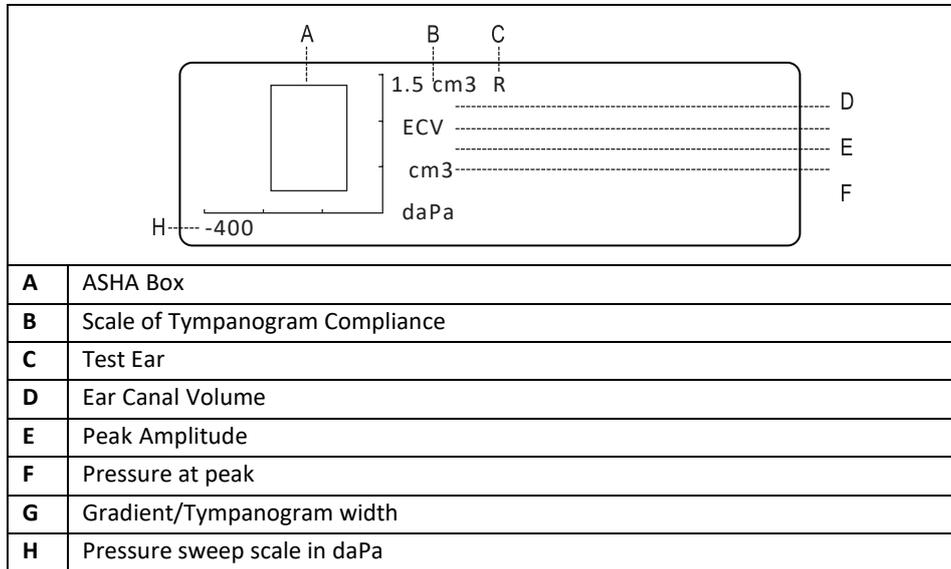

226 Hz Tympanometry/Reflex Screen

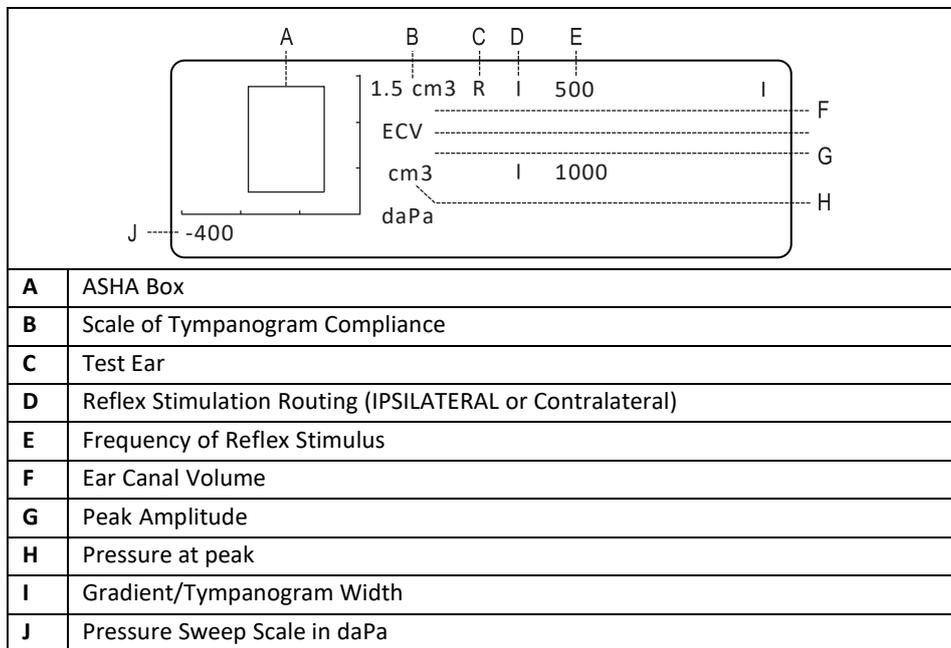

1000 Hz Tympanometry Screen

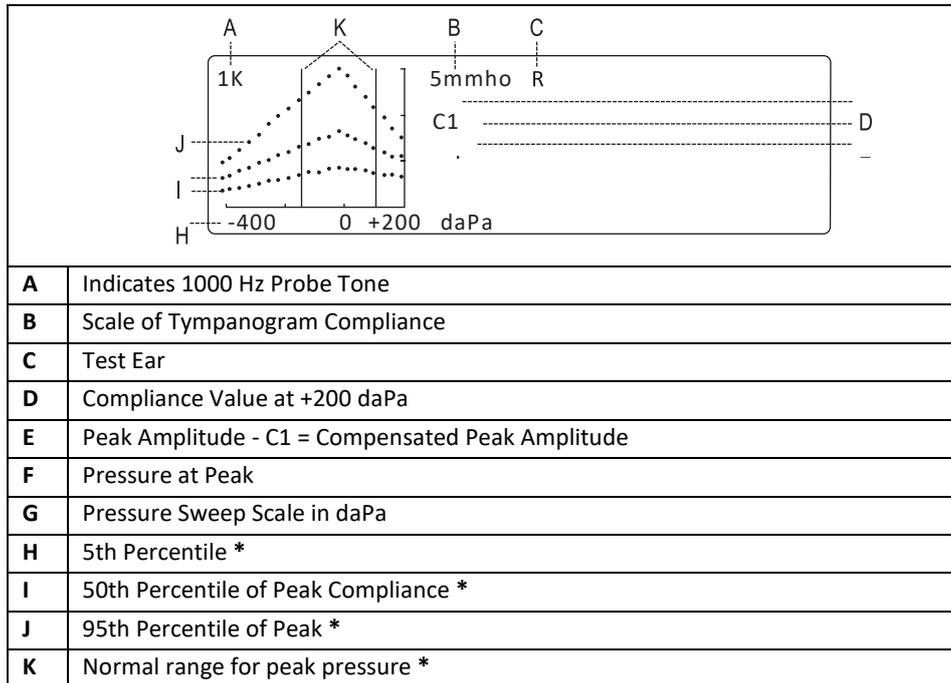

* Margolis et. al.

1000 Hz Tympanometry/Reflex Screen

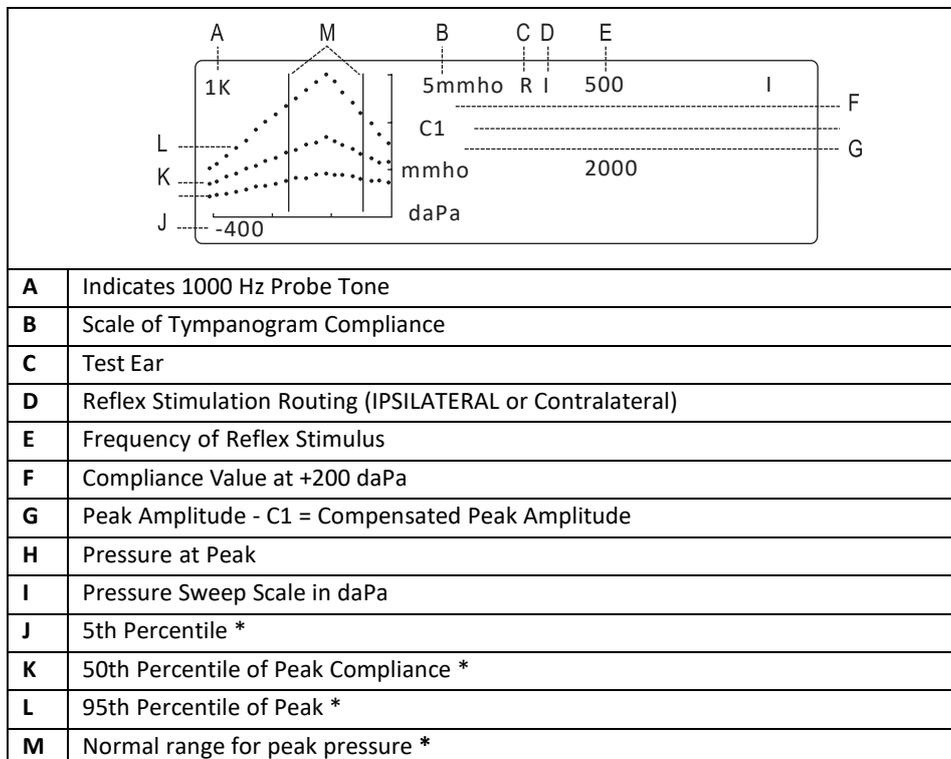

* Margolis et. al.

Audiometry Screen

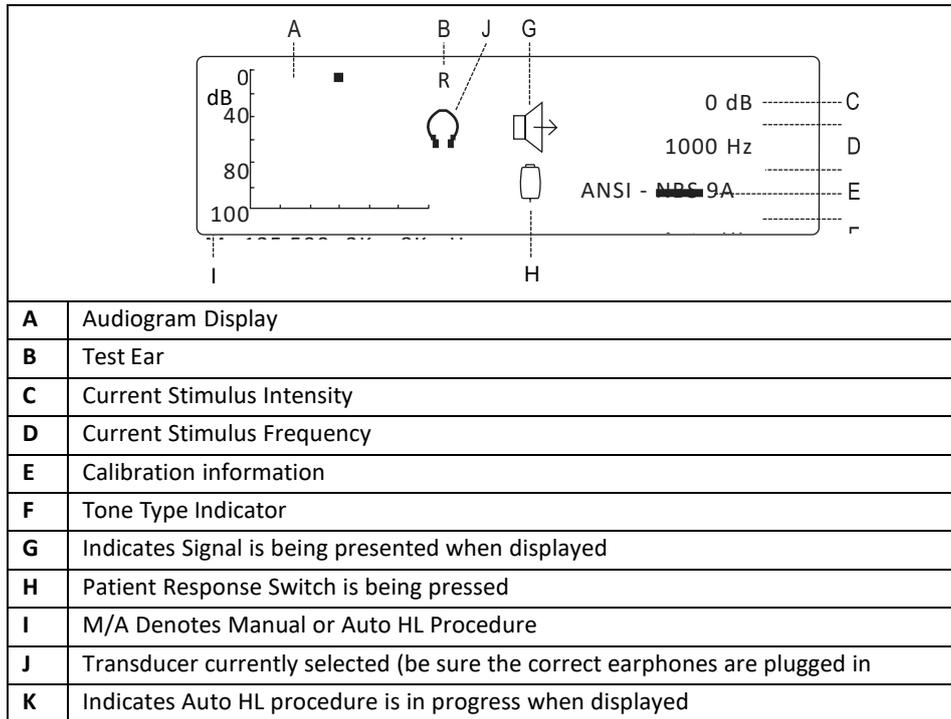

Tympanometry Testing Information

It is good practice to perform a test on a normal ear each day to make certain that the instrument is functioning properly. See **Biological Check** section for details.

Helpful hints

Tympanometry and acoustic reflex testing can be performed on patients of any age; however, the technique used will vary with age. From three years through adult, tympanometry can be performed with little difficulty due to the cooperative nature of this age group. With patients under three years old, a bit of ingenuity is required to keep the patient relatively quiet during the seconds required for the test. In all cases, distraction is the key to success. Anything that provides a sound and/or visual distraction should work.

Sucking on a pacifier or a bottle will help with the younger population. However, the tympanogram tracing will not appear as smooth due to the movement artifact. Having a parent hold an infant during testing will also help. For the 1000 Hz probe tone on infants, we recommend turning the **Auto Start** option off (factory default setting). This will allow the probe to be positioned and will allow repeated tests without removing the probe.

The key to success in all cases is to be at eye level with the ear canal. Use a steady hand monitor the ear canal and probe lights until the test is over. It is a good idea upon first receiving the instrument to practice on a cooperative patient to gain confidence in its use.

Obtaining a Seal

WARNING



A GSI Provided Probe Tip must be used. Using the probe without a Probe Tip could result in injury to the subject

Six different size eartips are provided with this instrument. The size of eartip will vary with size of the individual patient. Generally speaking, the following criteria apply:

- Premie - 8 mm
- Newborn - 8 mm, 11 mm
- Pre-school -11 mm, 13 mm
- School age -11 mm, 13 mm, 15 mm
- Adult -15 mm, 17 mm, 19 mm

NOTE: Before attempting to seal the entrance of the ear canal, visually inspect the opening to make sure that the canal is free of any obstruction. If the canal is completely plugged at the entrance or if fluid is running from the ear canal, tympanometry should not be attempted until the condition is cleared.

NOTE: Damage to the probe can result if fluid is sucked into the probe with negative pressure.

1. Place the appropriate size eartip onto the nose cone of the probe, making sure the rounded tip of the eartip sits flush with the tip of the nose cone (See Image below).

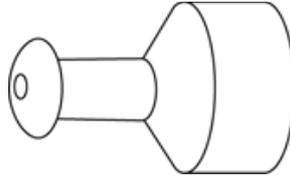

Positioning the eartip (226 Hz only probe)

2. Move any hair away from the ear and pull up and back on the pinna (pull downward and back on the pinna of a young child.) This will straighten out the ear canal and enable better results. Keep the pinna in this position throughout the test sequence.
3. Make sure that the **green** lamp on the probe is blinking.
4. Position the probe up against the entrance of the ear canal, applying a gentle pressure to maintain a tight seal (See image below).

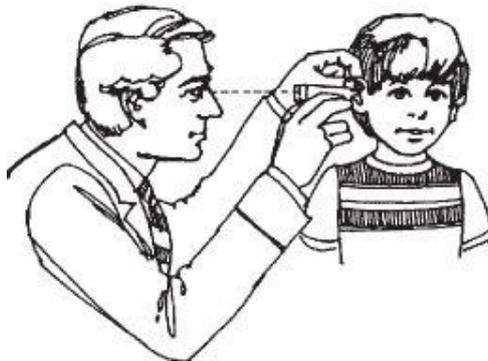

Positioning the probe (226 Hz only probe).

1. Watch the probe lamp. As soon as a good seal is obtained, the blinking green lamp will change to a steady glow and remain steady while the test is in progress.
2. When the test sequence is over, all lamps on the probe will turn off and the test result can be viewed on the instrument display before printing. It is now appropriate to remove the probe from the ear canal.

NOTE: The green lamp blinking again, signifying that another test can be started. The probe lamps will display status of the evaluation:

- **Green lamp:** Blinking - seal has not been obtained to initiate the test sequence.
- **Orange lamp:** The ear canal is not properly sealed and a large pressure leak exists.
- **Yellow lamp:** The probe tip is occluded with cerumen or the tip of the probe against the ear

canal wall causing an occlusion.

It is best to remove the probe, examine the tip for cerumen and clean it if necessary. A change of eartip size may also be appropriate. Start the test again.

Combo Probe Insertion

Select the proper eartip and position it fully on the probe. The eartip should be pushed firmly onto the tip of the probe until it is fully seated. The three probe tubes should be nearly flush with the top surface of the eartip.

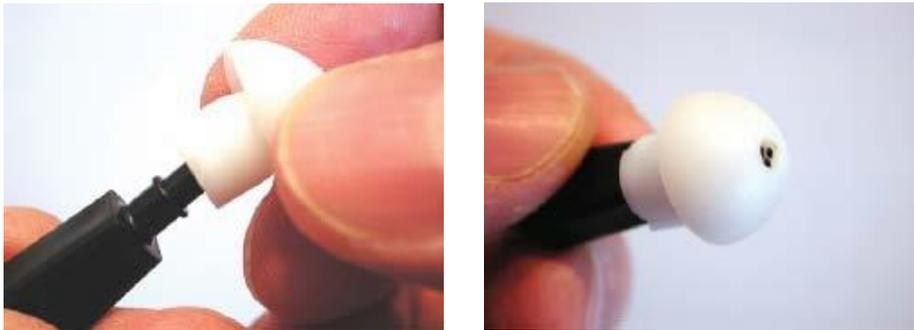

Inserting the Combo Probe

Insert the probe tip securely into the ear canal with a twisting motion. Pull the pinna up and back for adults, and down and back for children to straighten the ear canal. The probe tip should sit firmly within the ear canal without being held. If a leak occurs, a different size eartip may be needed.

Audiometry Testing (Version 3 and Version 4)

Prior to testing, ensure that the earphone cords are plugged into the appropriate connectors on the rear panel of the instrument. Both Headphones and Insert phones are available. Select the appropriate transducer and the desired tone type (i.e., pulsed, steady, or FM).

CAUTION



Always handle earphones with care. Neither drop them nor permit them to be squeezed together. Severe mechanical shock may change their operating characteristics and require their replacement. Insert the earphone cords between the earphone cushions during storage to prevent damage from mechanical shock.

INSTRUCTING THE PATIENT

Put the patient/subject as much at ease as possible before the test begins. In addition, it is important to try to make them understand how the test is to be conducted and what they will hear. For sake of uniformity, an unvarying explanation is advisable, for example:

“I am going to place these earphones over your ears. You will hear tones or beeping sounds which may be loud or soft. Whenever you hear, or think you hear one of these tones, raise your hand. Lower your hand when you no longer hear the sound. Remember, raise your hand when you hear the tone and lower your hand when you do not.”

NOTE: Modify the instructions accordingly if Insert phones are being used or if indicating the sound is heard using the available handswitch.

WARNING



Any program aimed at obtaining reliable records of hearing thresholds should be staffed and supervised by appropriately-trained individuals. Training courses leading to certification are available for audiometric technicians in most urban areas.

PLACEMENT OF EARPHONES

The most important thing to remember is that a good seal is required between the earphone cushion and the subject's/patient's head and ears. To increase the likelihood of a good seal,

- a. Eliminate all obstruction between the earphones and the ears (e.g., hair, eyeglasses, earrings, hearing aids, etc.).
- b. Adjust the headband so that it rests solidly on the crown of the subject's head and exerts firm pressure on both ears.
- c. Center the earphones carefully over both ears. The earphone with the red connector goes on the right ear. Take care to eliminate any visible gaps between the earphone cushions and portions of the individual's head and the ear on which the cushion rests.

PLACEMENT OF INSERT PHONES

1. Examine the ear canal for obstruction or excessive cerumen.
2. Make sure the sound tube is not blocked.
3. Place the black tubing of an ER-3A foam eartip completely onto the connector of the sound tube.
4. Roll the foam tip into the smallest diameter possible.
5. Insert the eartip well into the ear canal. Interaural attenuation is improved with deep insertion.
6. Allow foam to expand to acoustically seal ear canal.
7. Discard foam eartips after a single use.

NOTE: If using insert phones, ensure the appropriately sized foam tip is selected.

RESPONSE HANDSWITCH (OPTIONAL ACCESSORY)

If the optional handswitch is used, make sure that the handswitch connector is properly inserted into the jack on the rear panel. The instrument will display an appropriate symbol whenever the handswitch is pressed.

Tympanometry/Reflex Test Sequence

This section describes the test sequences for all modes of operation. Since there are five versions of the GSI 39, all of the test sequences described may not apply to this particular unit.

If a test sequence is not available on a system, “Invalid” will display on the LCD screen. All systems are capable of being upgraded to add test modalities. Contact a local GSI Representative for more details on upgrade packages.

TYMPANOMETRY ONLY MODE

1. Select the **Tympanometry only** mode by pressing  on the front panel. The display will immediately show the format for the tympanogram along with the summary information headers ECV, cm³, daPa, and GR. For 226 Hz Probe tone, the default scale for compliance is 1.5 cm³. If a compliance peak greater than 1.5 cm³ is measured, the instrument automatically scales the compliance axis to 3.0 cm³ so that more of the tympanogram data can be seen. For 1000 Hz Probe tone, the default scale is Baseline Off and will display a 5 mmho scale. If a larger compliance peak is measured, the instrument automatically scales the compliance axis to 10 mmhos.
2. Determine the test ear and select the appropriate ear (**R** or **L**) button so that the test results will be labeled properly. It is not possible to change the test ear after the probe is placed in the ear canal.
3. Examine the ear canal to determine the appropriate size eartip for the test and position the eartip on the probe. Be certain that the eartip is pushed as far down the probe tip as possible so that the eartip is flush with the tip of the probe.
4. Note that the green lamp is blinking, which indicates that the instrument is ready to begin the test.
5. Place the probe up against the entrance of the ear canal so that its opening is completely covered with the eartip and there are no visible leaks.
6. For 226 Hz, the test sequence begins when the instrument determines that a volume between 0.2 cm³ and 5.0 cm³ is present. This is indicated by the green lamp changing from blinking to steady. From this point on, hold the probe securely in this same position without any movement. Monitor the probe and the individual's ear. At the start of the test, the pressure system establishes a pressure of +200 daPa within the ear canal. When this pressure is achieved, the instrument makes a measurement of ear canal volume. This information is valuable as it indicates whether a good seal has been established and helps to differentiate between two similar Tympanogram types (i.e., a fluid-filled middle-ear system and a perforated tympanic membrane). After the ear canal volume (ECV) is obtained, this compliance value is subtracted from the remaining compliance measurements so that a direct reading of the tympanogram compliance peak is possible.

The pressure sweep begins at the starting pressure of +200 daPa and proceeds in the negative direction at a rate of 600 daPa/second. Measurements of compliance are made continuously as the pressure sweep continues in the negative direction. The slope of the tympanogram increases as the measurement approaches the compliance peak. This signals the instrument to decrease the rate of pressure sweep to 200 daPa/second to ensure a more accurate reading of the compliance peak. After the peak compliance and pressure values are detected and stored, the tympanogram dips downward toward the baseline (i.e., 0 cm³) and the pressure sweep rate increases back to 600 daPa/second. The tympanogram sweep ends automatically when the compliance value returns to baseline and the pressure is at least -100 daPa. Only when the middle-ear pressure is very negative is it necessary for the pressure sweep to continue to -400 daPa. The automatic stop when the tympanogram compliance returns to baseline eliminates unnecessary pressurization of the ear and shortens the test time.

When the tympanogram is completed and the test is finished, the steady green lamp turns off and the test results are displayed.

For the 1000 Hz probe tone, the measurement taken at +200 daPa will be identified as C1 and will not be a calculated volume. For the 1000 Hz probe tone, the default setting for Auto Start is turned off. This setting is recommended to ensure the probe is placed properly in the ear

canal prior to testing. To begin the pressure sweep, press the ► button.

The pressure sweep rate of 200 daPa/second remains steady through the peak measurement and will continue to -400 daPa. The green lamp will turn off when the test is completed.

The test results are stored automatically in memory. The actual memory location number is determined by the number of tests that are stored. For example, if this is the first test to be stored in memory, it will be assigned the number M1. If it is the third test to be stored in memory, it will be numbered M3, etc.

In addition to the tympanogram tracing, the screen displays the test summary information. For 226 Hz probe tones, this data includes the ear canal volume (ECV), the compliance peak in cm³, the pressure at the peak of the tympanogram in daPa, and the gradient (GR) as a peak width value. This test result can be printed out immediately as a single test by selecting the Print Screen Only  button or other tests can be performed and saved before all tests in memory are printed via the Print All  button. For 1000 Hz probe tones, the data accompanying the tympanogram will include a C1 value (in mmhos), a mmho compensated peak value (Peak - C1 = compensated peak in mmhos), and Peak Pressure in daPas.

NOTE: If a second tympanogram needs to be performed for 226 Hz, remove the probe and reinsert the probe. If Autostart is turned off on the 1000 Hz test, the probe does not need to be removed to run a second tympanogram. Press the ► button to start a 2nd measurement. If the pump cannot run a 2nd tympanogram due to pressure equalization, **remove** will appear on the bottom right of the LCD. Remove the probe and reinsert for the next tympanogram.

TYMPANOMETRY AND IPSILATERAL REFLEX

The default parameters for this test are tympanometry followed by an ipsilateral acoustic reflex test at 1000 Hz (2000 Hz for 1000 Hz probe tone).

When a seal is obtained, the tympanometry sequence is initiated. (See topic *Tympanometry only mode* earlier in this chapter for details). As long as no large leak is encountered during tympanometry (orange lamp illuminated) and no occlusion is detected (yellow lamp illuminated), the test automatically transitions to the reflex portion of the test as follows:

1. For 226 Hz probe tones, the pressure from the tympanogram peak compliance is re-established within the ear canal and is offset by -20 daPa so as to avoid any problems with extremely sharp tympanogram slopes (+20 daPa for positive peak pressure). For 1000 Hz probe tones, the pressure is re-established to 0 daPa for reflex measurements.
2. With the air pressure held constant throughout the reflex test sequence, the lowest intensity level for the starting frequency is presented and a measurement of compliance change is made. If the compliance change of at least 0.05 cm³ for the 226 Hz probe tone and 0.1 mmho for the 1000 Hz probe tone is measured, this reflex intensity level is stored in memory, as a response.
3. If no other frequencies were selected for the test, the Tymp Reflex sequence ends here. The green lamp is no longer illuminated indicating that it is appropriate to remove the probe from the ear. The display will indicate the reflex test result as a Yes, as an HL value, or as an HL value plus a tracing of the reflex response curve. The default setting established in the Program mode determines the manner in which the reflex result is displayed. See *Program Mode* section.
4. If no response is measured (i.e., for 226 Hz probe tone, a compliance change of at least 0.05 cm³ was not detected) at the lowest intensity level, the intensity level of the stimulus is automatically increased by 10 dB. If a response is detected, the test sequence for this frequency ends and either the result is displayed on the screen or the test advances to the next frequency selected. However, if no response is measured, the intensity level is increased by 10 dB (e.g., 1000 Hz Ipsi = 105 dB HL) and the stimulus is presented.
5. After the response is detected, the intensity level is stored as the reflex test result and displayed on the screen. If no response is detected at the highest intensity level, either a No or an NR (depending upon the Program mode setting) is indicated on the screen next to the frequency tested label. If a large pressure leak develops, an NT will appear on the screen next to the reflex test frequency and the test sequence is aborted.
6. The same sequence is followed for each test stimulus selected.

NOTE: To change the test default frequencies, see *226 Hz Reflex* and *1000 Hz Reflex* in *Program Mode* section.

The intensity levels available vary with the frequency selected ipsilaterally as follows:

IPSILATERAL	Intensity Levels
500 Hz	80, 90, 100 dB HL
1000 Hz	85, 95, 105 dB HL
2000 Hz	85, 95, 105 dB HL
*4000 Hz	80, 90, 100 dB HL

226 Hz Probe Tone

IPSILATERAL	Intensity Levels
500 Hz	80, 90 dB HL
2000 Hz	85, 95 dB HL
4000 Hz	80, 90 dB HL

1000 Hz Probe Tone

NOTE: 1000 Hz is not available when using the 1000 Hz Probe Tone option.

NOTE: Although four frequencies are available during the tymp and ipsilateral reflex test mode, most situations require only one or two frequencies to be tested. A selection of the most commonly used frequencies is available; however, it is strongly recommended that only one to two frequencies per test are selected. Holding the probe in the same position for the length of time required to test four frequencies may become uncomfortable for both the tester and individual being tested.

* Only 80 and 90 dB HL are available on the Combo Probe.

TEMPORARY PROGRAMMING OF IPSILATERAL ACOUSTIC REFLEX TEST FREQUENCIES

The instrument defaults to a 1000 Hz Ipsilateral test stimulus when the **TYMP REFLEX** button is first pressed. Any combination of the four available frequencies (500, 1000, 2000, 4000 Hz) for 226 Hz Probe Tone and three frequencies (500, 2000, 4000 Hz) for 1000 Hz Probe Tone can be selected either temporarily or as revised default parameters. To temporarily modify the default condition:

1. Press the **Tymp Reflex** TYMP REFLEX button.
2. Select the test **frequencies** by pressing the desired Frequency button (e.g., ^{500 Hz} or ^{1000 Hz}). Pressing the Frequency button a second time will deselect that frequency from the test sequence. Test frequencies must be selected before the probe is in the ear. Each frequency selected will be indicated on the display. For example, if 2000 Hz is selected along with 1000 Hz, the label "I 1000" will appear at the top of the first column of numbers for reflex and "I 2000" will appear directly below it. If 500 is also selected, the screen will be modified so that "I 500" appears at the top of the first column of reflex numbers, "I 1000" will appear directly below "I 500" and "I 2000" will appear at the top of the second column of reflex numbers and directly to the right of "I 500" and so on.

To change the default setting, see the *Program Mode* section.

TYMPANOMETRY AND CONTRALATERAL REFLEX (VERSION 2 AND VERSION 3)

To select tympanometry and contralateral reflex testing:

1. Press the **Tymp Reflex** TYMP REFLEX mode button. This initializes the GSI 39 to perform a tympanogram along with reflex measurements. The factory default setting for reflexes is 1000 Hz Ipsilateral presentation.
2. To temporarily change the system to perform Contralateral Reflexes only, you first deselect the 1000 Hz Ipsilateral. To deselect the 1000 Hz IPSILATERAL, simply press the 1000 HZ button, "1000" should no longer be displayed on the right side of the LCD.
3. Press the **CONTRA** CONTRA button. This displays the letter **C** in front of the frequency labels.
4. Select the test frequencies by pressing the desired Frequency button (e.g., 500 HZ or 1000 HZ). Pressing the Frequency button a second time will deselect that frequency from the test sequence. Test frequencies must be selected before the probe is in the ear canal.
5. Before initiating this test sequence, select the appropriate **size eartip** for the contralateral insert phone from the color-coded eartip container. The insert phone should fit snugly in the ear canal.
6. Push the selected eartip firmly onto the insert phone. Be sure to carefully position the insert phone within the ear canal as the calibration depends upon a proper seal of the ear canal.
7. Select the test ear by pressing **R** or **L**. According to general convention for recording contralateral reflexes, the test ear is the ear where the probe is positioned and the stimulus ear is the ear that contains the contralateral insert phone. If the contralateral insert phone is placed in the left ear, the test ear is the right ear since this is the ear from which the reflex response is to be measured. Press the button that corresponds to the ear with the probe to select the test ear.

To initiate the test:

1. Position the insert phone securely within the ear canal to receive the contralateral stimulus.
2. Position the probe into the ear canal of the test ear. Note that the green lamp changes from a blinking to a steady state when the test begins.
3. Monitor the probe and the ear canal throughout the test sequence. The test begins with the tympanogram and is followed immediately by the contralateral acoustic reflex test.

For **226 Hz Probe Tone**, the pressure value used within the test ear throughout the contralateral stimulus presentations is the peak pressure obtained during the tympanogram offset by -20 daPa (+20 daPa if peak pressure is positive).

For **226 Hz Probe Tone**, a compliance change of 0.05 cm³ indicates a reflex response. Up to three intensity levels per frequency selected are presented. The format in which the test results are displayed on the screen is determined by the default setting chosen in the Program mode (i.e., yes/no, dB HL, or dB HL and response curve). The three intensity levels available per frequency are the same for all four (500, 1000, 2000, and 4000 Hz) possible frequencies, 90, 100, and 110 dB HL.

For **1000 Hz Probe Tone**, the reflexes will be measured at 0 daPa and a compliance change of ≥ 0.1 mmho is required. Up to 2 intensity levels per frequency are presented.

NOTE: The second or third intensity level presentations occur only if a response is not detected at the prior intensity level. The test is over when the green lamp on the probe is no longer illuminated.

TYMPANOMETRY AND IPSILATERAL/CONTRALATERAL REFLEXES (VERSION 2 AND VERSION 3)

This test sequence can be selected either temporarily or set as the default sequence. If both ipsilateral and contralateral testing are performed only with certain patients, it is advisable to only change the test parameters temporarily on an as needed basis. However, if the test protocol calls for ipsilateral and contralateral testing with all patients, it is advisable to change the default settings. (See *226 Hz Reflex* or *1000 Hz Reflex* under **Program Mode** section).

Ipsilateral and Contralateral Acoustic Reflex testing

There are 4 frequencies of either Ipsilateral or Contralateral stimulus presentations available. They can be all Ipsilateral, all Contralateral or a combination of both Ipsilateral and Contralateral. Ipsilateral will always be presented first and the frequencies will always go from low to high. Any combination of Ipsilateral and Contralateral frequencies can be programmed into the 4 stimulus conditions. For example,

I	500	C	1000
C	500	C	2000

or

I	500	I	2000
I	1000	C	1000

Press the ^{TYMP}REFLEX button to select the Tymp/reflex mode.

Press the ^{IPSI} button and select and deselect ipsilateral reflexes using the frequency buttons.

Press the ^{CONTRA} button and select contralateral reflexes required using the frequency buttons.

NOTE: A total of 4 reflex frequencies are allowed. It is not possible to select a 5th reflex. To choose different reflexes, you must first deselect those reflexes not desired.

Before initiating the test:

Position the insert phone securely in the ear canal of the contralateral reflex ear.

Position the probe into the ear canal of the test ear. When the green lamp changes from a blinking to a steady state, the test sequence begins. First, a tympanogram is obtained and then, for 226 Hz probe tone, the peak pressure from the compliance peak offsets by -20 daPa (or a + 20daPa for a positive pressure peak). For 1000 Hz, the system is reset to 0 daPa. The reflex sequence begins automatically by starting with the lowest ipsilateral test frequency and is followed by a second ipsilateral test frequency if selected. After the ipsilateral reflex tests are completed, the instrument sequences automatically to the contralateral reflex test stimuli. The lowest frequency is presented first and is then followed by the next frequency. Monitor the ear canal where the probe is positioned. When the green probe lamp is no longer illuminated, the test is complete and it is appropriate to remove the probe and the insert phone from the ears. The reflex test results can now be observed on the display

screen. The format in which the ipsilateral and contralateral reflex test results are displayed is dependent upon the setting chosen in the Program mode.

Exit tympanometry/reflex

To exit **Tymp Only Mode**:

Select **Tymp Reflex** or **Audiometry Mode**. Note that the appropriate screen appears on the display.

To exit **Tymp/Reflex Mode**:

Select **Tymp** or **Audiometry Mode**. Note that the appropriate screen appears on the display.

Audiometry Sequence (Version 3 and Version 4)

TO ENTER THE AUDIOMETRY MODE

1. Press the **AUD** button. Note that the display changes from a Tympanogram or Tymp/Reflex format to an audiogram format.

TRANSDUCER SELECTION

Select the transducer to be used for the Audiometric testing. Press  to select headphones or to  select insert phones. The LCD will flash a picture of the transducer choice until the transducer button is pressed a second time. With one set of output jacks for the transducers, two buttons allow separate calibration files to be accessed. Be sure that the transducers that are connected to the back of the GSI 39 are the same as the selected transducer from the front panel. If Headphones are selected, a  will appear in the center of the LCD. If Insert Phones are selected, a  will appear in the center of the LCD.

The settings for the frequencies available during audiometry are defined in the Program mode as 125 through 8000 Hz (normal) or 500 through 6000 Hz (narrow). The factory default setting is the normal frequency range of 125 through 8000 Hz. Upon entering the audiometry mode, the starting frequency is automatically selected to be a steady signal of 1000 Hz at 0 dB HL.

The signal format can be temporarily changed from steady (continuous) to a pulsed or frequency modulated tone. These alternative tone formats remain selected until a different test is selected. The display indicates a **continuous bar** when steady is selected, a **dashed bar** when pulsed is selected, and the letters **FM** when frequency modulation is selected.

The audiometry defaults to testing the right ear first. To start with the left ear, it is necessary to press the **L** button after entering the audiometry mode. Since the audiometry mode defaults to 1000 Hz at 0 dB HL, the cursor is positioned at the corresponding location on the audiogram.

Please note that even though tabular format may be selected for the audiometric test results on the printout, the LCD display is always in the audiogram format.

To change the frequency

1. Press the  **Hz** button.
2. If the  **Hz** button is pressed once momentarily, the frequency increases to the next frequency in the range.
3. If the  **Hz** button is held down continuously, it is possible to quickly scroll through the available frequencies. Note that if the button is held down past the 8000 Hz in the normal range (6000 Hz for the narrow range), the frequency scroll wraps around to the lowest frequencies (i.e., 125 Hz with the normal range and 500 Hz with the narrow frequency range). The reverse occurs if the  **Hz** button is pressed.

In addition to changing the frequency, the  and  buttons change the position of the cursor on the audiogram. The frequency value of the cursor position on the audiogram is displayed on the right side of the screen.

To change the intensity level of the test tone

1. Rotate the **dB HL** knob in the clockwise direction to increase the intensity level in 5 dB steps; rotate the knob in the counterclockwise direction to decrease the intensity level in 5 dB steps.

The cursor on the audiogram moves up and down accordingly. Also, the dB level displayed above the frequency value on the right-hand side of the audiogram changes. For each frequency, there is a fixed intensity range available while rotating the **dB HL** knob as follows:

Frequency	Intensity Range
125 Hz	-10 to 50 dB HL
250 Hz	-10 to 70 dB HL
500 to 4000 Hz	-10 to 90 dB HL
6000 Hz	-10 to 85 dB HL
8000 Hz	-10 to 70 dB HL

It is possible to extend the intensity range per frequency 10 dB by pressing the ^{10dB} button. The button may only be selected when the intensity level is set to the highest value in the normal range. For example, with the test tone of 1000 Hz, the normal intensity limit is 90 dB HL. When the intensity knob is rotated clockwise to select beyond 90 dB HL, the intensity value above the 1000 Hz to the right of the audiogram flashes indicating the maximum intensity limit has been reached. To go beyond 90 dB HL, select the ^{10dB} button. A large + sign appears on the screen below the 1000 Hz value. The **dB HL** knob can be rotated through two additional positions, 95 and 100 dB HL. Rotating the **dB HL** knob to the next position beyond 100 dB causes the intensity value 100 to flash on the screen to the right of the audiogram; this indicates that the maximum dB HL for the extended range has been reached. If the dB HL is rotated one more position beyond the flashing 100 dB position, the letters NR appear next to the letters dB above the 1000 Hz. This permits the selection of the no response (NR) symbol on the audiogram during testing. The extended range remains selected until either the intensity level for that particular frequency (e.g., 1000 Hz) is brought down 5 positions below the maximum dB HL value (e.g., 65 dB HL for 1000 Hz) or the frequency is changed.

To save the threshold for a frequency, press the **M+** button. The appropriate symbol (**O** for right ear and **X** for left ear) for the test ear will replace the cursor. If no response (NR) was measured, an arrow is attached to the O or X symbol on the audiogram. The last threshold obtained and saved with the **M+** button becomes the value saved in memory and is the value printed on the audiometric test results.

To present the tone to the test ear, press the **Present** bar. A speaker symbol  appears in the center of the screen for as long as the **Present** bar is depressed.

NOTE: Although the printout will combine the right and left ear test results on the same audiogram or table, the screen can display only the results from one ear at a time. Therefore, if an ear button (**R** or **L**) is selected while you are still testing a particular ear, the screen will change to a new audiogram. If this happens, it is not possible to return to an incomplete audiogram to complete the test sequence.

Screening audiometry

1. Carefully position the earphones over the individual's ears so that the **red phone** covers the right ear and the **blue phone** covers the left ear.
2. Ensure that nothing is obstructing the earphones such as earrings, eye glasses or a hearing aid.
3. Instruct the person being tested to raise a hand or a finger (or press the optional **Handswitch**) whenever a tone is heard.
4. Encourage the patient to respond even if he/she thinks a tone is heard.
5. Select the ear to be tested with the **R** (right) or **L** (left) button.
6. Select the desired screening intensity by rotating the **dB HL** knob to the appropriate position. The American Speech Language and Hearing Association recommends 20 dB as the screening level for school-age children.
7. Select the starting frequency by pressing the ◀ or ▶ **Hz** buttons.
8. Present the tone by pressing the **Present** bar.
9. If the individual fails to respond, increase the intensity by 10 dB and try again. Press the **Mt** button at the intensity level where the individual responded.
10. Continue the procedure for all the desired frequencies.

AUDIOMETRIC THRESHOLD

The GSI 39 provides two ways to perform Audiometric Threshold testing. The system can be used in a Manual mode or an Automatic Hearing Level mode (**Auto HL mode**). In the Manual mode, the intensity, frequency and presentation of the stimulus are controlled by the tester. In the Auto HL mode, the system presents stimuli based on responses from the Patient Response switch.

Manual Threshold Audiometry

1. Carefully position the earphones and select the ear to be tested.
2. Familiarize the individual with the test procedure by presenting a tone of 40 dB HL at 1000 Hz.
3. Decrease the intensity in 10 dB steps until the person no longer responds or until you reach 0 dB HL.
4. When you believe the individual understands the procedure (i.e., raise your hand/finger when you hear a tone) proceed with the test.
5. Starting at the desired test frequency, present the tone for a period of one or two seconds.
6. If a response is indicated,
 - a. Decrease the intensity of this same test frequency by 10 dB and present the tone again for

- one to two seconds.
- b. If no response is indicated, increase the intensity by 5 dB. Present the tone again.
 - c. If no response is indicated, increase the intensity by another 5 dB.
 - d. If a response is indicated, this is the second time that the individual responded to the same intensity level. Repeat the sequence of down 10 dB and up in 5 dB increments to determine if a correct response is detected at the same intensity level. The threshold is considered to be the minimum level at which a response has occurred two out of three times. Press the **M+** button when this intensity level is indicated on the screen above the test frequency to signify that the threshold level for that frequency has been reached. Note that the appropriate symbol (**O** = right, **X** = left) appears at the correct intensity level where the threshold was determined.
7. Repeat this test sequence for each frequency to be tested.
 8. When the thresholds have been obtained for all the desired frequencies, select the other ear and repeat the sequence. Note that the display changes to a new screen for storing the second ear's results. The test protocol follows a down 10 dB and up 5 dB sequence to establish threshold level.

AUTOMATIC HEARING LEVEL

The Automated Hearing Level Procedure (Auto HL) allows the patient to control the evaluation using the response button. The software determines the presentation level of the stimulus based on the Hughson-Westlake Threshold estimation procedure (reference). The patient should be instructed to hold the button down when s/he hears the tone and release the button when the tone goes off. In this procedure, the stimulus level is decreased 10 dB each time the patient presses the button and increased by 5 dB when the button is not pressed. The GSI 39 will present the stimulus and increase or decrease the intensity of the stimulus based on the patient response. The GSI 39 monitors the response/no response stimuli and determines the hearing threshold based on the data.

Theory of Operation

The following bullet points describe the stimulus presentation patterns and patient response validity

1. The stimulus on-time is fixed at 1.5 seconds.
2. The Inter-stimulus interval is randomized between 3 and 5 seconds.
3. When a valid response occurs, the intensity for the next stimulus presentation is decreased 10 dB. When no valid response occurs, the intensity of the next stimulus presentation is increased 5 dB. This is based on the Hughson-Westlake down 10, up 5 dB rule used by most audiologists during threshold testing.
4. The system will determine the response to be valid if the patient response switch is pressed during the stimulus or for 2 seconds following the stimulus off time.
5. The system will determine the patient response to be invalid based on the following occurrences:
 - a. The patient response switch is pressed during the stimulus on time, but not released before

- the start time for the next intensity presentation.
- b. The patient response switch is pressed and released only during randomized inter-stimulus interval.
- c. The patient response switch is pressed and released more than 2 times during the stimulus on and completion of inter-stimulus interval.

Threshold results are displayed as they are saved for each frequency. When the first ear test sequence is completed, the audiometric thresholds for all the frequencies tested are stored in memory. At the start of the second test ear sequence, the results on the LCD will be cleared to display the second ear results. When the second ear sequence is completed, the entire audiogram containing thresholds for both ears are stored in memory. The threshold series for any frequency will be considered invalid if a threshold is not achieved within 18 stimulus presentations, or if the retest result at 1000 Hz does not agree within 5 dB of the first result. If the threshold results are considered invalid, the system will exit the Auto HL procedure. The audiogram results obtained thus far will be kept and displayed so that the test can be completed manually.

Performing the Auto HL Procedure

1. Instruct the patient to press the button on the handswitch when s/he hears the tone and release the button when the tone goes off.
2. Carefully place the headphones or insert earphones.
3. To begin the Auto HL procedure, press the **AUD** button and hold it for 3 seconds. The words **Auto HL** will be displayed at the bottom right corner of the LCD indicating that the Auto HL procedure has been engaged. The first stimulus will be presented when the **AUD** button is released. When a signal is presented, the Speaker  icon will display on the LCD.
4. When all frequencies have been successfully tested the **Auto HL** will disappear from the LCD indicating the test is finished.

Exit audiometry

There are two ways to exit the audiometry mode.

- a. Select the **Tymp** mode ^{TYMP} button
- or -
- b. Select the **Tymp Reflex** mode

For details on programming the Auto ^{TYMP} ^{REFLEX} HL procedure, refer to *Programming the Auto HL Procedure* section.

TESTS IN MEMORY

The Tymp and Tymp Reflex test results are automatically stored in memory when the test sequence ends. Audiometric test results are stored in memory when ^{M+} is pressed. A total of 12 memory pages are available with the GSI 39. Each Tymp, Tymp/Reflex or individual ear in audiometry is assigned a page in memory. They are labelled M1 - M12.

Page mode

To review the individual test results, press the  button and enter "Page mode." The word "Page" will be displayed in the center of the LCD. Testing cannot be performed while the system is in the Page Mode. The memory number is located in the upper right-hand corner of each screen. If, for example, only five tests were stored in memory, only five memory locations can be viewed. The memory can be reviewed one page at a time by pressing the  or  button once and observing the result. The entire memory can be scrolled through by holding the  or  buttons down continuously. Press the  button to exit "Page Mode" and continue testing.

Memory erase

If there is a particular test result that must be to delete before printing, enter the Page mode by pressing . Press  or  to display the test result and press . This erases that particular test result from memory. The LCD displays a blank screen for erased memories with the memory location number located at the top right corner. Upon exiting from the Page mode, the stored memories reshuffle and replace the empty memory with the remaining tests in the order in which they were obtained. The Page mode will be exited when you press the **PRINT ALL**  or **ERASE ALL**  buttons or any button that would normally begin the setup of a new test. Page Mode is ready only. No changes can be made to audiometric results.

To erase all tests from memory, press the **ERASE ALL**  button.

Printing test results

The printout will begin with a header, if it is selected, in the program mode (i.e., GSI 39 or a custom header). The next two lines contain space for recording the individuals name and the test date. This is followed by the test results in the order they were obtained/ selected.

Either a single test can be printed from memory or the entire group of tests in memory can be printed. To print a single test from memory, use the **PAGE**  button to enter the Page mode and the  or  button to arrive at the desired test result to print. When this test is displayed, press the **PRINT SCREEN**  button.

To print all tests in memory, press the **PRINT ALL**  button. When **PRINT ALL**  is pressed and two audiogram tests are stored in memory, they will combine under the following conditions. There must be one left test and one right test sequentially stored in memory. A left and right audiometric pair of tests will not be combined if they are separated in the memory by a Tymp test. Therefore, when tests are erased, the result could cause a change in (left, right) or (right, left) sequence with Audiometric tests. This would result in the wrong audiometric tests being combined when **PRINT ALL**  is selected. Prior to selecting **PRINT ALL**  scroll through the tests in memory to determine where the audiometric tests are located.

To avoid accidental confusion of data, **ERASE ALL**  before starting a new test patient.

PROGRAM MODE

Program Mode

To enter the program mode, press the **PROG** button located on the front panel. There are two screens for the Program mode. To move to the second page, press the Increase Frequency  button or turn the Attenuator knob  until the cursor is next to the arrow on the bottom right column. Press  to enter Page 2.

Basic button functions for moving through the Program menu	
 (Cursor)  (Attenuator Knob)	Moves the cursor sequentially through the list of options on the screen.
M+	Toggles the option on or off. An asterisk (*) appears to the left of the item to denote the item has been selected. Pressing M+ again removes the asterisk, which deselects the item.
 (Page)	Use this button to move to the submenu or next page of a menu.
Save	The word Save should appear on the lower right corner of the LCD after the M+ button has been selected.
• • •	Indicates there is a submenu. Select  to enter the submenu.

PROGRAM MODE MENU ITEMS

The following screen appears the first time you program mode is entered.

PROGRAM MENU PAGE 1		PROGRAM MENU PAGE 2	
PROBE HZ...	AUD RANGE NORMAL	DATA XFER CONFIG...	INTERNAL PRINTER
TYMP OPTIONS...	AUD RANGE NARROW	POWER UP SETTINGS	EXTERNAL PRINTER
REFLEX DISPLAY...	PRINT – AUDIOGRAM	PRN HEADER GSI...	RESET TO DEFAULTS
226 HZ REFLEX...	PRINT - AUD TABLE	PRN HEADER OFF	
1 KHZ REFLEX...	DEF XDUCER TDH 39	PRN HEADER CUSTOM	
AUTO HL SETUP	DEF XDUCER INSERT		
LANGUAGE			

NOTE: Pushing the **Print** button while in Program mode will print out the currently programmed settings.

NOTE: The GSI 39 is available in 5 versions, each containing different testing modalities. When navigating through the Program menu, features that are not available on the GSI 39 version purchased will be represented by **invalid** on the LCD.

NOTE: Factory Default settings are listed at the end of this chapter.

Program Menu Page 1 Option Descriptions

PROBE HZ . . .

This submenu determines probe frequency that is displayed upon startup. Move the cursor to the desired frequency and press the ^{M+} button to save the selection.

226 Hz

1000 Hz

TYMP OPTIONS . . .

This submenu determines tympanogram display and test options.

NORMAL BOX ASHA		BASELINE ON	1k
NORMAL BOX OFF		BASELINE OFF	1k
NEWBORN NRM ON	1k	AUTOSTART ON	1k
NEWBORN NRM OFF	1k	AUTOSTART OFF	1k
50 TH PERCNT ON	1k		
50 TH PERCNT OFF	1k		

NORMAL BOX ASHA/NORMAL BOX OFF

For 226 Hz Probe Tone, it is possible to have the Normal Box, as defined by ASHA, appear on the tympanogram screen and printout. The boundaries for this Normal Box are -150 daPa to +100 daPa and 0.2 cm to 1.4 cm³.

NOTE: A compliance value of 1.5 cm³ or greater will turn off the ASHA normal box automatically.

NORMAL BOX ASHA is the factory default setting. To select the **NORMAL BOX**

OFF, move the cursor next to the selection and press the ^{M+} button to save. **Saved** should appear on the bottom right corner of the LCD and an **"***" should appear next to the **NORMAL BOX OFF** option to denote the selection.

NEWBORN NRM ON 1k / NEWBORN NRM OFF 1k

For 1000 Hz Probe Tone, it is possible to have the normal box, as described by Margolis, et.al., appear on the tympanogram screen and printout. The **NEWBORN NRM ON 1k** is the factory default. The **NEWBORN NRM ON 1k** are represented on the display by dashed lines at the 5th or 95th percentile. To select the **NEWBORN NRM OFF 1k** option, move the cursor to the selection and press the  button to save. **Saved** should appear on the bottom right corner of the LCD and an "*" should appear next to the **NEWBORN NRM OFF 1k** option to denote the selection.

50th PERCNT ON 1k / 50thPERCNT OFF 1k

In the normative data by Margolis, et. al., a dashed line representing the 50th percentile of the infant population is presented. This dashed line can be turned off by selecting **50th PERCNT OFF** and pressing the  button to save the selection.

BASELINE ON 1k / BASELINE OFF 1k

BASELINE ON 1k: The C1 value in mmhos is obtained at +200 daPa and then subtracted from the tympanogram tracing so that it begins at the 0 mmhos position on the tympanogram display (compensated tympanogram data is displayed).

BASELINE ON 1k, you must also select **NEWBORN NORM OFF 1k**.

BASELINE OFF 1k: The C1 value in mmhos is obtained at +200 daPa; the tympanogram tracing begins at this amplitude at the +200 daPa position (uncompensated tympanogram data is displayed).

From the Patient Information screen you can **Review** the patient's test history (if test data exists for the patient), **Test** the patient or go back to the previous screen from selections in the bottom Menu bar.

AUTOSTART ON 1k / AUTOSTART OFF 1k

For the 1000 Hz option, you can turn off the Autostart option can be turned off by selecting the

AUTOSTART OFF 1K option. Move the cursor to **AUTOSTART OFF 1K** and press the  button to save the selection.

If **AUTOSTART** is **Off**, press the  button to start the test.

NOTE: Turning off the Autostart feature will allow ample time to situate the probe in the ear before the testing begins. This feature also allows for repeat tympanograms to be obtained quickly without having to remove the probe.

Reflex Display

Reflex test results can be displayed and printed in three different formats:

REFLEX DB HL PLUS CURVE

The default setting for this grouping is **Reflex dB HL plus curve**. All reflex test results will appear on the display and printout with the following information:

- I** (Ipsilateral) or **C** (Contralateral) if available and selected
- Frequency:** 500, 1000, 2000, or 4000 Hz
- Intensity** level where response was detected
- Tracing of actual response curve.

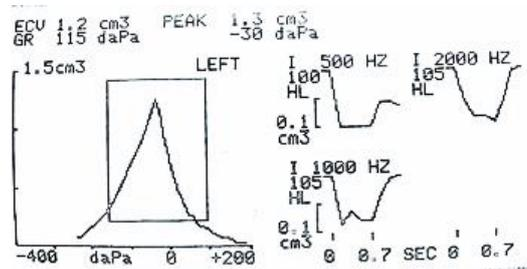

Display format for TYMP/REFLEX Test

(Reflex test results with dB HL value and tracing)

REFLEX DB HL ONLY

If **Reflex dB HL only** is selected, the stimulus frequency, stimulus routing, and the dB HL level for the reflex will appear on the display and printout.

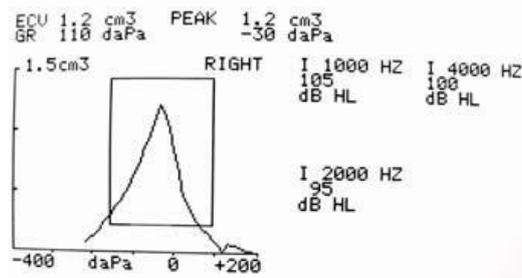

Display format for TYMP/REFLEX Test

(Reflex test results given in dB HL)

REFLEX YES/NO

If **Reflex yes/no** is selected, the dB HL result will be replaced with the word **yes** (response detected at one of three levels) or **no** (no response detected).

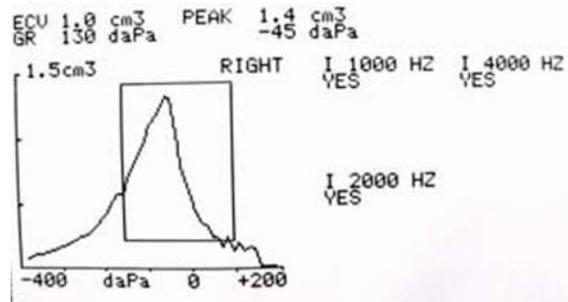

**Display format for TYMP/REFLEX Test
(Reflex test results given as Yes or No)**

When the reflex test cannot be performed, due to a leak or early extraction of the probe, a “NT” will appear next to the frequency.

To select a different setting for reflex format:

1. While in the Program mode, move the cursor to the desired setting.
2. While the square cursor is positioned in front of the desired setting, press the button.

The word **SAVED** appears in the lower right corner of the screen. The previous setting is deselected. An asterisk (*) is displayed besides the new default setting.

226 HZ REFLEX

Ipsi	500	Contra	500
Ipsi	1000	Contra	1000
Ipsi	2000	Contra	2000
Ipsi	4000	Contra	4000

This feature determines the stimuli and signal routing of the acoustic reflexes as default settings. To select the frequencies, move the cursor next to the selection and press the **M+** button to save. **Saved** will appear on the bottom right corner of the LCD. An * will appear next to the selected stimulus routing and frequency. The system will allow 4 stimulus choices of any combination (i.e., ipsilateral or contralateral) for display and printing.

1000 HZ REFLEX

Ipsi	500	Contra	500
Ipsi	2000	Contra	2000
Ipsi	4000	Contra	4000

NOTE: 1000 Hz reflex stimulus is not available for the 1000 Hz probe option. This feature determines the stimuli and signal routing of the acoustic reflexes as default settings. To select the frequencies, move the cursor next to the selection and press the **M+** button to save. **Saved** will appear on the bottom right corner of the LCD. An * will appear next to the selected stimulus routing and frequency. The system will allow 4 stimulus choices of any combination (i.e., ipsilateral or contralateral) for display and printing.

AUTO HL SETUP

Programming the Auto HL Procedure

Navigate the cursor to the **Auto HL Setup** line located on the **Program Mode Screen 1** and press the  button. The following submenu will appear:

Test Frequencies (Hz) . . .
Intensity Range (dB HL) . . .
Start test ear . . .
Scoring rule . . .
Tone Format . . .

Place the cursor next to the line item, press the  button to enter the submenu item. Auto HL features are selected in the Program mode by placing the cursor next to the parameter and pressing the **M+** button to engage the selection. To exit this submenu, move the cursor to **→** and  press.

Test Frequencies (Hz)

This submenu determines the frequencies to be tested during the Auto HL procedure. Move the cursor to the frequency and press the **M+** button to select or deselect the frequencies for presentation during the Auto HL procedure. An asterisk next to the frequency denotes that it has been selected for presentation. The submenu will appear as follows with the factory default settings:

Test frequencies (Hz)	
125	*2000
250	*3000
*500	*4000
750	*6000
*1000	8000
1500	Return to Auto HL Set

Intensity Range (dB Hz)

This submenu defines the minimum and maximum decibel level (HL) that will be presented during testing. To change the Min. dB (lowest level), place the  cursor on that line and turn the **HL knob** on the front panel to the desired level. Press the  to move the **→** cursor to the Max dB line and use the **HL knob** again to change the maximum level. Press the  button to **→** move the cursor to the **Return to Auto HL Setup** and press  to  exit the submenu. Asterisks on this menu denote factory default settings.

LANGUAGE

Six language selections are available. Use **▶** to highlight **LANGUAGE** and press the  button to enter the Language submenu and then move the cursor to the language desired. Press the **M+** button to activate the selected language. The following languages are available.

- ENGLISH
- SPANISH
- ITALIAN
- GERMAN
- FRENCH
- PORTUGUESE

The new language will activate immediately upon exiting the Language submenu.

AUD RANGE NORMAL/AUD RANGE NARROW

All eleven frequencies are available during audiometry or the range can be abbreviated to eight frequencies. The default setting is **Aud Range Normal**. To select the abbreviated frequency range: Position the square cursor in front of the feature **Aud Range Narrow**. Press the **M+** button to save this narrow range for audiometric testing. The word **SAVED** will appear in the lower right-hand corner and the asterisk now appears in front of the narrow range selection. The normal range of frequencies includes 125 Hz through 8000 Hz. The narrow range of frequencies includes 500 Hz through 6000 Hz. In the **AUD** mode, if the narrow range is selected, the **◀** and **▶ Hz** buttons will allow you to scroll through this abbreviated frequency range only. Both the screen and printout will still be labeled with the full range of frequencies (i.e., 125 Hz through 8000 Hz).

Print - Audiogram/Print – Aud Table

The audiometric test results can be printed out in an audiogram format (**PRINT - AUDIOGRAM**) or in a tabular format (**PRINT - AUD TABLE**). The default setting for this function is the print audiogram format.

NOTE: When a specific frequency is not tested, the result will be a break in the audiogram on the printout. This eliminates the assumption that a threshold exists at that untested frequency.

To change the print option, move the cursor in front of the description **PRINT - AUD TABLE**. Press the **M+** icon to save this format as the new default parameter. The word **SAVED** appears in the lower right-hand corner of the display to indicate that this new setting has been saved. With the **PRINT - AUD TABLE** selected, all audiometric test results will appear in a table with the frequency range typed horizontally along the top of the table followed by two lines of test data. The test results for the right ear will appear next to the letter **R** and below each frequency tested. The test results from the left ear will follow below the right ear results.

NOTE: The **PRINT - AUD TABLE** setting selects the format for the printout only. An audiogram always appears on the LCD while in **AUD Mode**.

DEF XDUCER DD45 / DEF XDUCER INSERT

The **DD45 HEADPHONES** are the factory default transducers. To select the **INSERT EARPHONES** as the default start up option, move the cursor next to the **DEF XDUCER INSERT** selection and press **M+** to save. **SAVED** will appear on the bottom right corner of the LCD. An **"*"** will appear next to the **DEF XDUCER INSERT** option to denote the selection.

Program Menu Page 2 option descriptions

DATA XFER CONFIG

* 115.2 KBAUD	* NO PARITY + 8-BIT
57.6 KBAUD	ODD PARITY + 7-BIT
38.4 KBAUD	EVN PARITY + 7-BIT
17.2	SPC PARITY + 7-BIT
9600 BAUD	* XON/XOFF DISABLED
4800 BAUD	XON/XOFF ENABLED

These settings are used to allow the data transfer from the GSI 39 to a computer. The settings must be the same on the GSI 39 and the computer. The factory defaults are defined by an *.

POWER UP SETTINGS

TYMP

* TYMP REFLEX

AUDIO

The feature determines the mode displayed upon start up. An asterisk will denote which option is selected to appear on the LCD when the system is first powered up. The factory default setting is TYMP REFLEX.

PRN Header GSI/PRN Header Off/PRN Header Custom

There are three options for the print header on the printout.

PRINT HEADER GSI

This is the factory default setting for this feature. Each time the **Print Screen**  or **Print All**  tests in memory buttons are pressed, the printout will begin with the label **GSI 39**.

PRINT HEADER OFF

If this option is selected, no header will be printed before any test results, which will save space and printout time.

PRINT HEADER CUSTOM

Select this option to design a custom header, which might be the name of an individual facility, department or company. To type in the custom header, position the square cursor in front of **PRN HEADER CUSTOM**. Press **M+** to select it as the new default setting. The word **SAVED** appears in the lower right corner.

If **PRN HEADER CUSTOM** is selected, a line cursor will flash in the left-hand corner below the words **PRN HEADER CUSTOM**. To “type” in the desired header, use the dB HL knob. Rotating the knob clockwise will sequence you through the alphabet in the forward direction and rotating this knob counterclockwise will sequence you through the characters in a reverse direction. The available character set is: A -Z; 0 - 9; and a blank space. A total of 35 character spaces are available. When the desired character is displayed, press the **M+** button to store it. The cursor will move into position for the next character. Select the next character and press **M+** to store. When the custom header is complete, press the **PROG** button to exit from the submenu. To change/delete a previously saved character, press the  to position the cursor at that character. Use the HL knob to select the new character to change or select the blank space to delete.

NOTE: To center the header, consider the length of the name to be inserted and calculate from the left margin where the header will begin. Type blank spaces to the start point of the custom header.

INTERNAL PRINTER / EXTERNAL PRINTER

These items toggle between either printing to the internal printer (4” paper) or sending the information to an external printer. The external printer is connected through a USB port on the back panel. The printer must be a DeskJet with PCL3 or PCL3GUI protocol.

To select the printer, move the cursor next to the Internal or External printer and press the **M+** button to save the setting.

RESET TO DEFAULTS

This option will reset the programmable settings to the GSI factory defaults.

Program Mode	FACTORY DEFAULT SETTINGS
AUDIOMETRY RESULTS	- PRINT – AUDIOGRAM
REFLEX RESULTS	- REFLEX HL + CURVE
226 Hz Reflex	- Ipsi 1000 Hz
1 kHz Reflex	- Ipsi 2000 Hz
NORMAL BOX	- NORMAL BOX ASHA
NEWBORN NORM	- NEWBORN NRM ON 1k
50th PERCENTILE	- 50th PERCENT ON 1k
BASELINE	- BASELINE OFF 1k
AUTOSTART	- AUTOSTART OFF 1k
AUDIOMETRY RANGE	- AUD RANGE NORMAL
DEFAULT TRANSDUCER	- TDH 39
PRINT HEADER	- PRN HEADER GSI
LANGUAGE	- ENGLISH
DATA XFER CONFIG	- 115.2 KBAUD
	NO PARITY + 8-BIT
	XON/XOFF DISABLED
POWER UP SETTING	- TYMP REFLEX
	226 Hz
PRINTER TYPE	- INTERNAL PRINTER
AUTO HL SETUP	
TEST FREQ (Hz)	- 500 Hz
	- 1000 Hz
	- 2000 Hz
	- 3000 Hz
	- 4000 Hz
	- 6000 Hz
INTEN RANGE (DBHL)	
MIN DB	- 0
MAX DB	- 90
START TEST EAR	- RIGHT
SCORING RULE	- 2 OUT OF 3
TONE FORMAT	-STEADY

Exiting the program mode

Press the **PROG** button to exit the program mode and return to the previously selected test mode.

ROUTINE MAINTENANCE

Pretest Tymp Checks

A test cavity is provided with this instrument. This test cavity enables the ability to quickly verify, on a daily basis, the proper calibration of the unit. GSI strongly recommends that this quick check is a part of the daily routine.

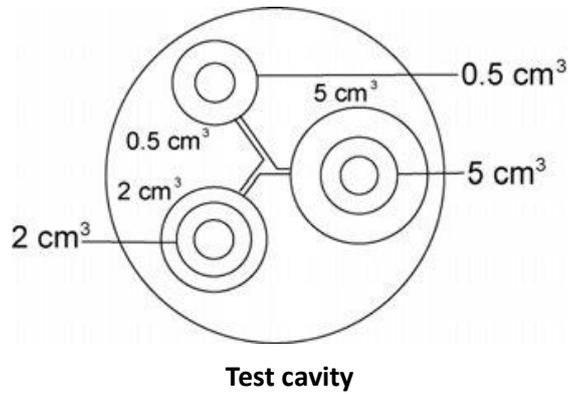

CALIBRATION QUICK CHECK FOR 226 HZ

To initiate the quick check, select the Tymp only mode and insert the probe into the 0.5 cm³ opening on the test cavity. See Figure 1.

The instrument is designed to start automatically, it is important that the probe is inserted as quickly and as smoothly as possible. During the calibration check, the probe must be held carefully and without movement. Do not place the probe on the same counter as the instrument or any moving object during this check as mechanical noise may be picked up by the probe and interfere with the calibration check.

The calibration check will start automatically if the probe has been inserted into the cavity properly. This is confirmed by the green lamp changing from blinking to a steady condition. If the **orange** lamp is illuminated, the probe is not properly positioned within the cavity so that a large pressure leak exists. If the **yellow** lamp is illuminated, the probe tip has been occluded. In either case, remove the probe and wait for the blinking **green** lamp. Insert the probe once again. If necessary, clean the probe tip as described later in this chapter.

The green lamp will resume blinking when the probe is removed from the test cavity. The tympanogram on the display represents the response from the 0.5 cm³ hard walled cavity. The ECV (ear canal volume) should read 0.5. The letters NP will appear alongside the pressure (daPa) and compliance (cm). Three dashed lines - - - will appear alongside the gradient (GR). Using the same sequence, place the probe in the test cavity opening labelled 2.0 cm³. The resulting tympanogram should be identical other than the ECV should read 2.0 cm³. The same sequence can be followed with the 5.0cm³ opening on the test cavity. To keep a record of this test cavity calibration check, simply press the  button on the front panel of the instrument.

Since sound pressure will vary with altitude and barometric pressure, some variation from the 0.5, 2.0 and 5.0 cm³ readings may be observed. The instrument is carefully calibrated at our factory, which is at approximately 850 feet above sea level. An elevation of 1000 feet or higher, the instrument may need to be recalibrated to account for elevation (see *Altitude Adjustment* in this chapter for more details). It is not necessary to recalibrate for barometric pressure changes on a daily basis. Keep in mind that a change in barometric pressure (i.e., from low to high or vice-versa) will slightly affect the test cavity readings.

CALIBRATION QUICK CHECK FOR COMBO PROBE

To perform a calibration quick check with the 226 Hz probe tone using the Combo probe, follow the directions on the previous page. To initiate the quick check for the 1000 Hz probe tone, select the Tymp only mode and 1000 Hz probe tone from the front panel. Insert the probe into the 0.5 cm³ opening on the test cavity. See Figure 1 earlier in this chapter. If the Autostart option is **Off**, press the ◀ to begin the measurement.

NOTE: The factory default settings on the Autostart option of the 1000 Hz probe tone will be set to **Off**.

When the test begins, the green lamp should change from blinking to a steady condition. If the blinking orange lamp is illuminated, the probe is not properly positioned within the cavity so that a large pressure leak exists. If the steady orange light is illuminated after the tip is inserted securely into the cavity, there may be an occlusion as the system considers the measurement too small to begin the test. In either case, remove the probe and wait for the blinking green lamp. Insert the probe once again. If necessary, clean the probe tip as described later in the maintenance section.

When the test sequence is completed, the green lamp on the probe is no longer illuminated. The green lamp will resume blinking when the probe is removed from the test cavity. If baseline is **Off** (factory default setting), there will be a flat line across the display at the amplitude of the cavity reading. If baseline is **On**, then there will be a flat line along the bottom of the display at the 0 value. The C1 value for 1000 Hz probe tone is represented in mmhos and not converted to a volume reading. The reading for the 0.5 Cavity should be 2.2 mmhos.

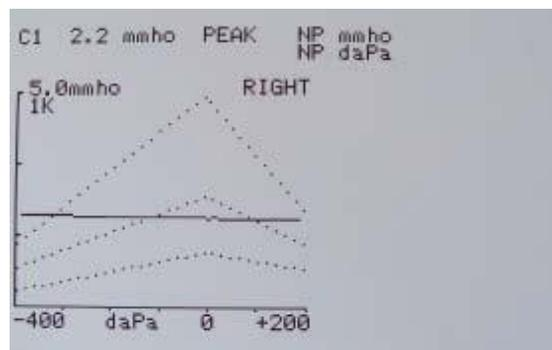

1000 Hz probe tone in 0.5 cavity with the baseline turned off

Since the test cavity is a hard-walled cavity, the tympanogram should be a flat line indicating that there is no mobility in the system. The instrument places the letters NP next to the mmho and daPa headers to indicate that there is no peak compliance and, therefore, no peak pressure can be determined during the quick check.

Using the same sequence, place the probe in the test cavity opening labeled 2.0 cm³. Note that when the measurement is finished, the display will change to 10 mmho scale and the normative data will no longer be displayed. The C1 value for the 2.0 cm³ cavity should be approximately 8.85 mmhos.

To keep a record of this test cavity calibration check, press the Print All button  on the front panel of the instrument.

Altitude Adjustment

The altitude calibration adjustment enables a “correction” to the ear canal volume (ECV) measurement and test cavity volume measurement for variations due to altitude. The instrument is a pressure sensitive device that makes measurements relative to ambient air pressure. Changes in air pressure due to weather or altitude will affect the ECV readout of the instrument. The slight pressure change resulting from changing weather conditions will usually yield volume readouts with $\pm 0.1 \text{ cm}^3$ of the expected cavity value, but pressure changes due to altitude can shift these cavity values by as much as 30%. These changes in pressure do not affect the accuracy of the compliance measurement system in any way. However, it will affect the ECV values. The altitude calibration mode allows adjustment of the Auto Tympanometry without the services of a qualified GSI representative.

226 Hz Probe		1000 Hz Probe	
Altitude in Feet	Equivalent 2.0 cc Reading	Altitude in Feet	mmho Reading
0	2.0 ± 0.1	0	8.85 mmho ± 0.44
1000	2.1 ± 0.1	1000	9.20 mmho ± 0.46
2000	2.2 ± 0.1	2000	9.56 mmho ± 0.48
3000	2.2 ± 0.1	3000	9.91 mmho ± 0.50
4000	2.3 ± 0.1	4000	10.3 mmho ± 0.52
5000	2.4 ± 0.1	5000	10.6 mmho ± 0.53
6000	2.5 ± 0.1	6000	11.1 mmho ± 0.56
7000	2.6 ± 0.1	7000	11.5 mmho ± 0.58
8000	2.7 ± 0.1	8000	12 mmho ± 0.60
9000	2.8 ± 0.1	9000	12.4 mmho ± 0.62
10000	2.9 ± 0.1	10000	12.8 mmho ± 0.64

226 Hz Probe Tone Altitude Correction	1000 Hz Probe Tone Altitude Correction
--	---

NOTE: Operation of the system at an altitude of 10,000 feet may affect the ability to pressurize to the maximum 5.00 cm^3 .

To enter altitude calibration, press ,  and  simultaneously. The LCD will now display the Settings Main Menu. When entering the Settings Main Menu, the display will read as follows:

Altitude - user check
Cal modes
Page modes

- Back to normal –

The cursor will be next to **Altitude - user** check. Press  to enter Altitude - user check.

1. When entering the altitude mode, the display will read as follows:
Altitude Mode
ECV 2.0
cm³ 9.99
Standard
2. Select **226 Hz** or **1000 Hz** probe tone.
3. Place the probe into the 2.0 cm³ cavity provided with the instrument and check the cm³ value against the altitude correction table for accuracy.
4. If the measured volume is not within the published table value ± 0.1 cm³, then exit the altitude mode by pressing the **PROGRAM MODE** button and contact field service. Providing the measured volume agrees with the published table ± 0.1 cm³, proceed with the altitude adjustment.
5. With the probe still in the 2.0 cm³ cavity, press the **PROG** button to enter the custom calibration mode. **CUSTOM** will appear on the fourth line of the display.
6. The value now displayed in the cm³ display area is the volume measured and adjusted to the current altitude. If the value displayed is 2.0 cm³, the volume is adjusted to the current site. If the value is not 2.0 cm³,
7. Press the **M+** **SAVE** button to adjust the volume measurement to the current altitude. The measured volume should now read 2.0 cm³.
8. To exit the altitude mode, press the **PAGE**  button to return to the Settings main menu.
9. Move the cursor using  and  **Back to Normal** and press the **PAGE**  button to return to the Normal mode.

NOTE: CAL MODES and DIAG MODES can only be accessed by GSI trained individuals. If these items are selected, "Invalid Selection" will flash on the bottom right to indicate they are currently disabled.

WARNING



GSI recommends only trained personnel enter the Calibration and Diagnostic submenus listed below the Altitude Adjustment in Calibration mode.

Pre-Test Audiometric Checks (Version 3 and 4 only)

NOISE RECOVERY PERIOD

Exposure to high levels of sound (e.g., unmuffled lawn mowers, loud music, and gunfire) tends to create a temporary threshold shift (TTS) which diminishes with time after exposure. Any subject/patient tested soon after such exposure may exhibit a hearing loss that does not reflect his or her normal hearing threshold. It is, therefore, important that the testing procedure prescribe some time interval - usually at least 16 hours- between the last exposure to high-level sounds and the administration of any hearing test.

ELIMINATION OF AMBIENT NOISE

At the time of purchase you chose your preferred style of acoustic transducer. If insert earphones were selected you also chose your preferred ear coupling method, the EarCup or the Ear tip.

Excessive noise in the test environment during audiometric testing such as that produced by conversation, typewriters, public address systems reduces test validity as it tends to mask the test signals, particularly at the lower frequencies where earphone cushions provide less effective attenuation. An acoustically treated room may be required if ambient noise reaches objectionable levels (i.e., sufficient to cause apparent hearing loss at the low frequencies). Also, Audiocups are available from GSI as an optional accessory. If the person being tested is in the same room as the audiometer, it is recommended that he/she be seated about three feet (1 meter) away from the instrument.

Maximum permissible noise levels are specified by the American National Standards – *Criteria for Permissible Background Noise during Audiometric Testing*, ears covered with earphones (S3.1 1991 revised). Table 3 shows the maximum background levels that can be present inside the room while a valid hearing test is being conducted. For more comprehensive information about hearing testing and hearing conservation, the user is referred to the Bibliography.

Frequency (Hz)	Test Room Maximum dB SPL* in 1/3 Octave Band
125	29.0
250	17.5
500	14.5
750	16.5
1000	21.5
1500	21.5
2000	23.0
3000	28.5
4000	29.5
6000	33.0
8000	38.5

Biological Check

For Tympanometry and Reflex tests, the best way to determine that the instrument is operating properly is to perform a daily check on a normal ear – the operator’s ear if possible. This allows the operator to listen for the probe tone and the stimulus tone (during reflex) and to determine if the air pressure system is working properly. Keep a copy of the tests for a day-to-day reference in checking the instrument.

To perform a biological check in Audiometry, select the Audiometry (**AUD**) mode button. The display changes from the tympanogram format to an Audiogram format. Select **Headphone** or **Insert Phone**. (When changing transducers, the icon for the new transducer will flash on the LCD until the button is pushed again). The ◀ and ▶ **Hz** buttons determine each frequency and the **dB HL** knob alters the intensity of each frequency. Position the test headset so that each earphone is covering the appropriate ear (i.e., **red** is right and **blue** is left). Select the right earphone by pressing the front panel button labelled **R** and check for the following while depressing the **Present bar**:

- a. Pressing the ◀ **Hz** button changes to a lower frequency.
Pressing the ▶ **Hz** button changes to a higher frequency.
- b. Each frequency or tone is pure (i.e., there is no distortion or crackling sound present).
- c. Rotating the **dB HL** knob in a clockwise direction to increases (becomes louder) the intensity. Rotating the **dB HL** knob in a counterclockwise direction decreases the intensity (becomes quieter).

Since individual thresholds can shift up or down as much as 5 dB from one day to the next, variation within this range may be considered acceptable. Variations that exceed this range, however, are likely to reveal problems that require attention. The routine maintenance checks described in this chapter, may suggest the source and solution to the problem. If they do not, the instrument should receive technical service by a GSI certified technician before further use.

Preventive Maintenance

Preventive maintenance includes periodically cleaning and inspecting the exterior of the instrument. It is recommended that you develop a schedule for these purposes. Unless otherwise noted, the frequency of instrument cleaning can be determined by the user, depending on the conditions and frequency of use. It is recommended that the instrument is cleaned at least annually.

CLEANING THE SYSTEM

Turn **OFF** the system and disconnect power before cleaning the instrument. Use a soft cloth lightly dampened with cleaning solution to clean all exposed surfaces. Take care to not allow liquid to come in contact with the metal parts inside the transducers (e.g., earphones / headphone). Do not permit solutions or Disinfecting agents to seep into the electronic portions of the system. Take special care around controls, connectors and panel edges. Remove any dust from the exterior of the system with a soft brush or cloth. Use a brush to dislodge any dirt on or around the connectors and panel edges. Remove stubborn dirt with a soft cloth slightly dampened with mild detergent and water. Wipe surfaces dry afterward. Do not use instrument or transducers until they are completely dry.

Cleaning and Disinfecting Agents

According to the recommendations from the CDC, audiometric equipment is considered to be non-critical medical equipment and typically requires cleansing followed by low- to intermediate-level disinfecting, depending on the nature of the contamination. Cleaning should be done with a mild soapy detergent (such as dishwashing liquid) and a damp cloth or an Endozyme Sponge followed by an application of EPA-registered hospital disinfectant. Do not use any abrasive cleaners.

Use of a non-alcohol based disinfectant is recommended for larger areas and headphones. Non-alcohol based products contain the active ingredient referred to as quaternary ammonia compound or hydrogen peroxide based cleaner such as Oxivir Disinfecting Wipes to clean the ear cushions, headset, and to wipe down the machine. The quaternary ammonia compound and hydrogen peroxide are specifically designed to disinfect rubber, plastic, silicone and acrylic products which are commonly used in hearing evaluation instruments.

CAUTION



Many common disinfectant wipes present in hospitals contain alcohol as a main disinfection ingredient. However, alcohol chemically denatures certain materials, such as the material used in the ear cushion. With repeated exposure to alcohol-based disinfectants, the earphone material will harden, crack and breakdown over time. The higher the alcohol content of the disinfectant, the faster the earphone will be affected. If alcohol disinfectant wipes are used to disinfect the earphone cushion it will need to be replaced more frequently than if a non-alcohol based disinfection product is used.

CLEANING PATIENT CONTACT REUSABLE DEVICES

To help insure patient safety, prevent cross infection and provide effective service, GSI devices must be properly maintained. Maintenance should include cleaning patient contact parts prior to each use. The earphone cushions and patient hand switch can be wiped with a slightly damp cloth containing soap and water ammonia based cleaners or bleach based cleaners. Gently wipe the earphone cushions with the slightly damp cloth taking care not to get moisture in the speaker portion of the earphones.

WARNING



It is recommended that all repairs be performed by a qualified GSI service representative only. Malfunctions resulting from improper maintenance or repair by anyone other than an authorized GSI representative will be the responsibility of the user.

Probe Care – 226 Hz Probe

With normal use, cerumen can work its way inside the probe nose cone (probe tip). During the warm-up period each day and throughout the day, inspect the probe tip to make sure it is clean and free of cerumen. Refer to the following instructions for cleaning and maintaining the instrument's probe.

PROBE NOSE CONE CLEANING

Remove the nose cone portion of the probe:

1. Hold the body of the probe in one hand (e.g., left) near the tip and grasp the nose cone of the probe in the other hand (e.g., right).
2. Rotate the nose cone portion of the probe counterclockwise until the nose cone is completely separated from the probe (Figure 3).
3. Place the probe body securely on a table and inspect the nose cone for cerumen. Use a pipe cleaner to remove any cerumen by inserting the pipe cleaner through the back portion of the nose cone and pulling it through the front opening. It may be necessary to repeat this several times to remove all the cerumen.

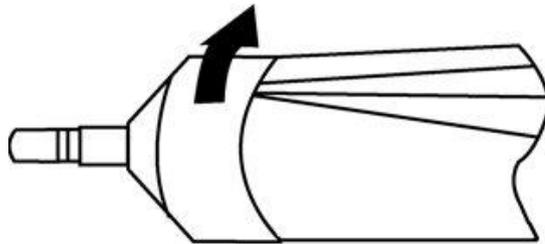

Probe nose cone removal

NOTE: The probe nose cone can be sterilized via conventional methods including autoclaving.

The O-Ring

There is an O-Ring seated at the end of the threads on the probe. As a preventative maintenance measure, and to ensure that the nose cone of the probe unscrews easily, do not clean or remove the lubricant from the O-Ring. If the O-Ring appears to be void of any lubricant, or if the nose cone itself was difficult to remove, apply a high-quality synthetic lubricant such as those considered “food-grade.” Refer to Figure 4 and apply as described in the instructions that follow.

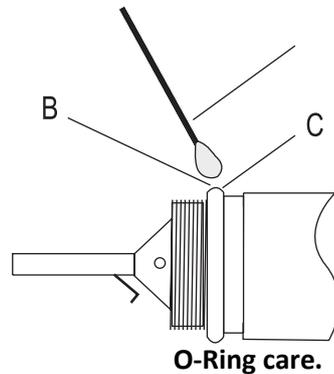

A: Cotton swab.

B: Lubricant

C: O-Ring (enlarged for detail).

1. Place a small drop of lubricant at the front outer surface of the O-Ring.
2. Using a finger or a cotton swab, spread a thin layer of lubricant completely around the front and outer surface of the O-Ring. Ensure that no lubricant spreads into the threaded area of the nose cone. Only a thin layer of lubricant is necessary. Excessive application or build-up may affect test results.

The probe wire

Inside the probe body, there is a metal tube that contains a wire required for cleaning purposes.

1. Carefully remove this wire from the metal tube (Figure 5). This will pull any cerumen out of the metal tube.

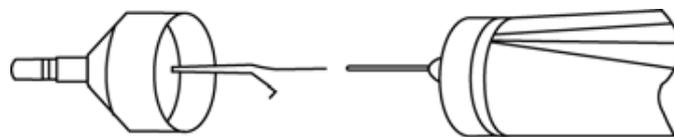

2. Examine the wire for cerumen.
3. If necessary, clean the wire with a lint-free tissue.
4. Reinsert the wire into the metal tube and push it in as far as it can go.

NOTE: The wire must be inserted into the metal tube for the instrument to function properly.

Probe reassembly

After cleaning, reassemble the probe nose cone to the probe body by screwing the cone back onto the probe. Take care to align the threads on both the probe body and the nose cone before screwing the pieces together. Only screw the nose cone on until it is finger tight. It may be helpful to gently squeeze the two sides of the probe case together while screwing the nose cone into place.

NOTE: The probe nose cone must be screwed firmly in place to guard against any air leaks.

Probe Care - Combo Probe Tip

To ensure measurement accuracy, it is essential to clean the probe tip daily to be certain that the tubes are clean and free of cerumen. If the lights on the probe are indicating an occlusion, cleaning the probe tubes will most likely rectify the situation.

The Cleaning Floss Kit contains 2 sizes of floss, which can be used to clean the three metal tubes on the probe tip.

1. Remove the probe eartip and tygon tubing attached to the three metal probe tubes at the rear of the probe tip.



WARNING



Do not alter the length of the tubing by cutting it. When reconnecting the tygon tubing to the probe tubes, ensure that there are no sharp edges or burrs on the probe tubes that could cut the tygon tubing.

1. Using the smaller sized floss, for one of the smaller size metal tubes, insert the floss into the base of the black probe tip and pull the floss through the metal tube. Discard the used floss.
2. Repeat with a second piece of the small floss for the other small tube.
3. Use the larger floss to clean the large tube of the probe tip in the same manner. Do not reuse the cleaning floss.



4. Use the larger floss to clean the large tube of the probe tip in the same manner. Do not reuse the cleaning floss.
5. Reconnect the tygon tubing to the metal probe tubes. The center tube has the larger diameter.



Tygon tubing should be replaced if debris can be seen in the tubing as this could affect accuracy of the measurements.

WARNING



Avoid getting the probe moist. Do not use the probe tip if it is wet or damp because the moisture may make its way to the sensitive electronic equipment at the end of the tygon tubing.

Earphone Care (Versions 3 and 4 only)

With proper care, the earphone and cords provided with the instrument (Versions 3 and 4) should last a long time. Moisture should not be allowed anywhere near the earphone itself as this will damage the diaphragm and grill cloth, requiring its replacement. The earphone cushions can be wiped with a slightly damp cloth, taking care not to get moisture in the speaker portion of the earphones.

With extended use, earphone cords tend to fray internally at the connectors (i.e., between the cord and the instrument's connector, and between the cord and the earphone connector). This fraying may cause a decrease in the signal level or cause the signal to be intermittent. To check for this:

1. Position the test headset properly and select a frequency (e.g., 1000 Hz) at 35 dB HL.
2. Select the right earphone and press the **Present bar**.
3. While the Present bar is depressed, flex the earphone cord next to the connector at both ends.
4. Listen for an intermittent signal, an abrupt change in signal intensity level or a scratchy sound superimposed over the selected frequency that coincides with the flexing of the cord. The presence of any of these conditions indicates that the cord should be replaced.
5. Also, examine the earphone cord for cuts or tears in the covering shield and the earphone cushion for signs of damage. If either problem is noticed, the earphone cord or cushion should be replaced. Both parts are easily replaced without the need for recalibration. However, if the earphone receives shock damage or is replaced for any reason, the instrument will need to be recalibrated.
6. Repeat this same sequence with the left earphone

Paper supply

To streamline each testing session, it is a good idea to check the amount of paper left inside the printer compartment. Extra rolls of paper should be kept nearby.

NOTE: The number of tests per roll of paper will vary with the version Auto Tymp being used and the type of tests being performed. See **Printer Description** in the **Specifications** section of this guide for approximations. Replacement paper can be purchased from a local GSI Distributor or from the factory.

TEST RESULTS

Ear canal Volume – 226 Hz Probe Tone

NORMAL

As a general rule, values for ear canal volume should be between 0.2 and 2.0 cm³. However, the normal values will vary with age and bone structure.

ABNORMAL

An ear canal value of less than 0.2 cm³ indicates an abnormal condition. If the probe is partially plugged with cerumen or if the probe is positioned against the ear canal wall, a smaller than expected value will be measured. Also, if an individual has a relatively large bone structure for his/her age group and a smaller than expected value is measured, the probe could also be partially occluded or against the canal wall. It is also possible to collapse the canal if the probe is held too firmly against it. Examine the Tympanogram and the reflex results to confirm results. If they are abnormal as well, it is good practice to repeat the test.

An ear canal volume greater than 2.0 cm³ also may indicate an abnormal condition. An important application of the ear canal volume measurement is to determine if there is a perforation of the tympanic membrane. If there is a perforation due to trauma or due to the presence of a pressure-equalization (P-E) tube, the measured ear canal volume will be much larger than normal since the combined volume of the ear canal and the middle-ear space is being measured. The maximum ECV is 5.0 cm³, any space larger than that will be recorded as 5.0 cm³ or may not seal.

Compliance Peak

NORMAL

The range of normals for compliance is 0.2 cm³ to approximately 1.4 cm³. Some protocols use a larger range up to 1.8 cm³. A measured compliance peak within this range indicates normal mobility within the middle-ear system.

ABNORMAL

A compliance value of less than 0.2 cm³ indicates a pathological condition as the middle-ear system is stiffer than normal. To distinguish the probable cause of the stiffening, the pressure value where this stiffened compliance peak occurs needs to be considered. For example, normal pressure along with a stiff middle ear system is indicative of otosclerosis, a severely scarred tympanic membrane or a layer of plaque across the tympanic membrane. On the other hand, abnormal pressure along with a stiffened middle-ear system is consistent with a poorly functioning eustachian tube with possible effusion (serous otitis media) or “glue ear.”

NOTE: If the measured compliance value is less than 0.1 cm³, the letters NP will be printed next to the heading cm³ on the screen and printout. The letters NP indicate a poorly defined or flat Tympanogram. The Tympanogram may depict a very shallow peak.

A compliance value greater than 1.4 cm³ (or 1.8 cm³) indicates a hyperflaccid tympanic membrane or a possible disarticulation depending upon how far above the normal range the value is. Generally speaking, a compliance value of greater than 3.0 cm³ is indicative of a disarticulated ossicular chain. Further testing is necessary to confirm this suspicion.

NOTE: If a compliance value is measured to be greater than 1.5 cm³, the instrument automatically changes the range assigned to the graph to 3.0 cm³.

The validity of tympanometry and acoustic reflex testing is dependent upon a healthy tympanic membrane. A pathological condition at this membrane can mask the true condition of the middle ear.

Pressure Peak

NORMAL

Strict rules for middle-ear pressure indicate a normal range of ± 50 daPa. However, for most applications, a normal range of -150 daPa to +100 daPa is used.

ABNORMAL

Very rarely, an extreme positive pressure condition will be observed. Some researchers have reported high positive pressures at the onset of acute otitis media.

Pressure values more negative than -150 daPa are indicative of a poorly functioning Eustachian tube. The severity of this condition is determined by how negative the pressure is and its impact on the compliance peak.

If no pressure peak is measured over the pressure range of +200 daPa to -400 daPa, then the letters NP will appear on the screen and the printout. This indicates that no pressure peak was detected over this pressure range.

Gradient

NORMAL

When testing a child, the normal range for the gradient is between 60 and 150 daPa. (Infants may show higher gradient values due to the mobility of their ear canals). The range of normal is somewhat narrower for adults (i.e., 50 to 110 daPa).

ABNORMAL

A high gradient value (greater than the high end of the normal range per age group) is indicative of middle-ear effusion. The reduced compliance values and negative middle-ear pressure characteristic of developing or resolving otitis media with effusion (OME) will be manifested in a broad tympanogram with a large gradient value. However, abnormal gradient values may also be found in the absence of abnormal parameters. This could indicate a transient OME, so a retest after several weeks may be recommended.

When the middle ear's mobility is reduced to near 0 cm^3 , due to viscous effusion or a "glue-ear" condition, no gradient value can be measured. In this case, dashes (- - -) will be displayed next to the letters GR.

Very low gradient values are associated with a flaccid middle ear system. These low values should be taken into consideration with the ear canal volume and compliance peak values to determine the probable use of the flaccid condition.

Acoustic reflex

NORMAL

For screening purposes, an ipsilateral or contralateral reflex measured at any one of the levels available per frequency can be considered normal. Obviously, the lowest values are desired. However, without knowing the hearing threshold level of the individual per frequency, it is difficult to make a more definite statement. Generally speaking, the reflex is reported to occur at between 70 and 90 dB HL above the hearing threshold in patients with normal hearing. Remember that these values apply to reflex threshold measurements and that this instrument does not permit reflex threshold measurements due to the use of a hand-held probe. The presence of a reflex in the absence of a compliance peak suggests that the tympanometric results should be considered invalid and the test repeated. This is true because if there is no compliance measured during tympanometry, it is not possible to measure any stiffening affect during the reflex stimulus presentation.

ABNORMAL

If a pressure leak occurs during the reflex testing and the pressure system is unable to correct for this leak, the reflex test sequence is aborted. When this occurs, the test results are assigned the letters NT (Not Tested).

If no response is obtained at the third and final stimulus level, the instrument will indicate this with the letters NR or No. More detailed testing at the frequency where this occurred is required to determine the reason for the no response.

Audiometry

NORMAL

A normal response from a child should be at or below 20 dB HL. A normal response from an adult is at or below 25 dB HL. Remember that these normal values assume a quiet environment during testing.

ABNORMAL

In children, a failure to respond to a 20 dB HL (or lower) stimulus presentation during a retest performed four to six weeks after the initial test would indicate the need for more extensive diagnostic testing to determine the cause.

In adults, a failure to respond at or below 25 dB HL when the room noise levels are low indicates the need for more evaluation. However, the age and employment history of the individual must also be considered.

Special Messages and Error Codes

Error code numbers and other special messages may be displayed on the screen or on the printout. These messages appear whenever an instrument error occurs or, in some instances, to apprise the operator of certain situations. For example, if there is no test result on the screen and the **Print Screen**  button is pressed, the printer will indicate “No Test to Print”

Error codes will appear as a two-digit number prefixed by the letter “E.” If an error code appears, please repeat the operation that caused the error code to appear. If the error code appears for the second time, make a note of it and contact a GSI service representative, and give him/her the exact error code number.

Sample Test Results

Figures 1 through 8 illustrate test results from sample GSI 39 Auto Tympanometry printouts. The smoothness of the tympanogram tracing is determined by the amount of movement during the testing. Little or no movement during the testing provides a smoother tracing. Moving, talking or crying during testing leads to a more erratic traces but does not dramatically affect the test results.

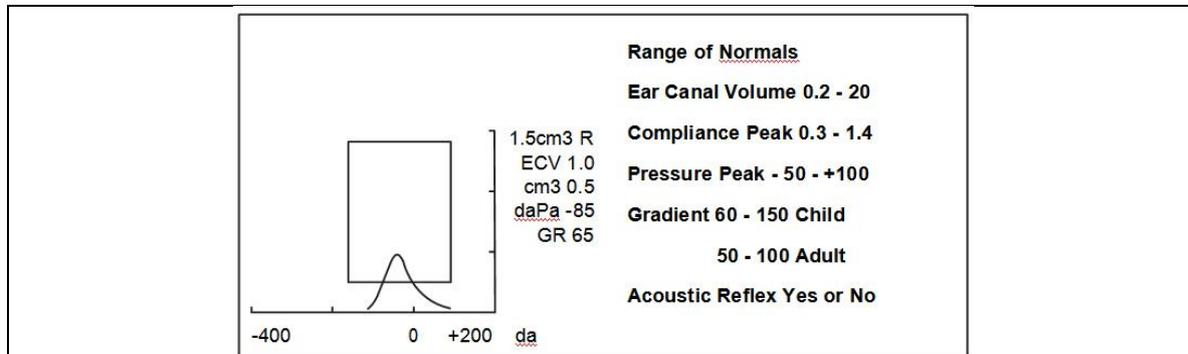

Figure 1: 226 Hz Range of Normals

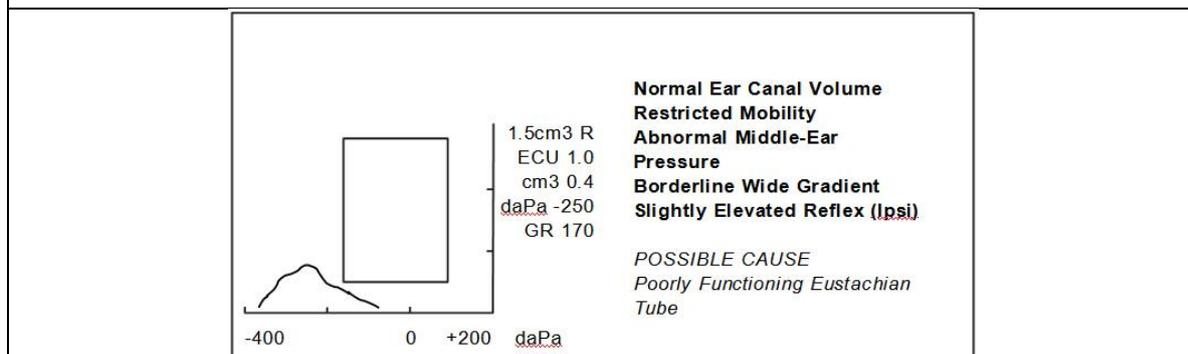

Figure 2: 226 Hz Abnormal Tympanogram

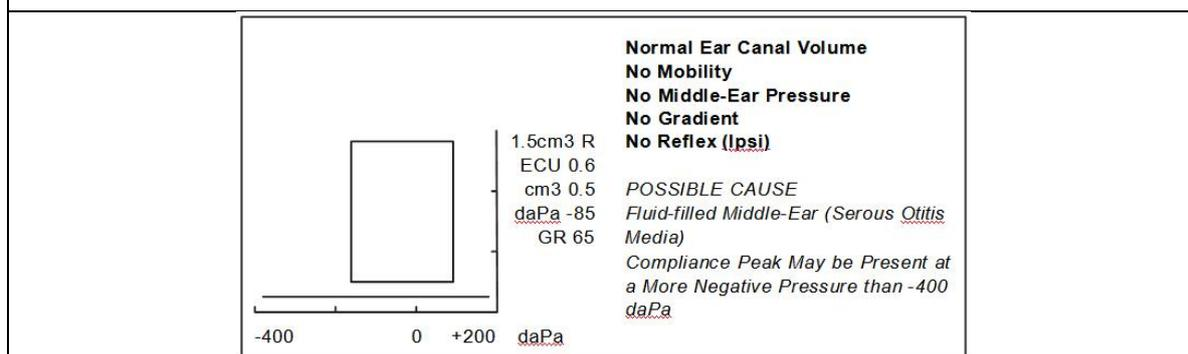

Figure 3: 226 Hz Abnormal Tympanogram

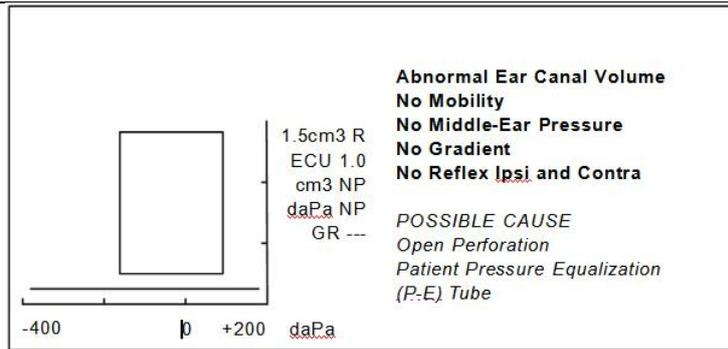

Figure 4: 226 Hz Abnormal Tympanogram

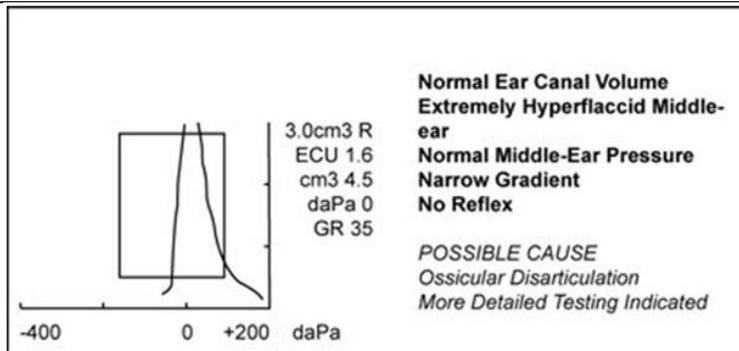

Figure 5: 226 Hz Abnormal Tympanogram

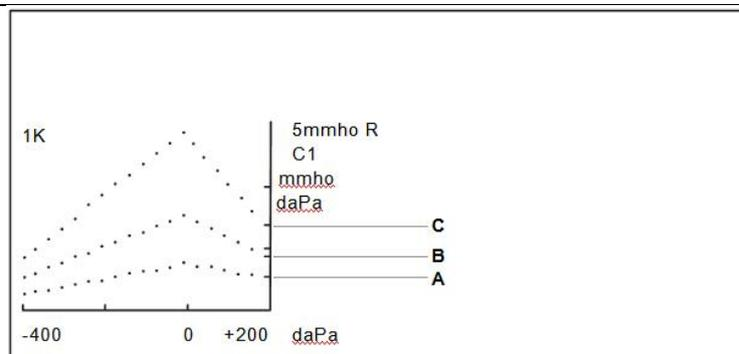

Figure 6: Infant Normative Data

Infant Normative Data Legend for Figure 6

	C1 y + 200 daPa	mmho y Peak Values	daPa Pressure at Peak
A	5% 0.8	5% 1.2	5% -133
B	50% 1.4	50% 2.5	50% 0
C	95% 2.2	95% 4.8	95% 113

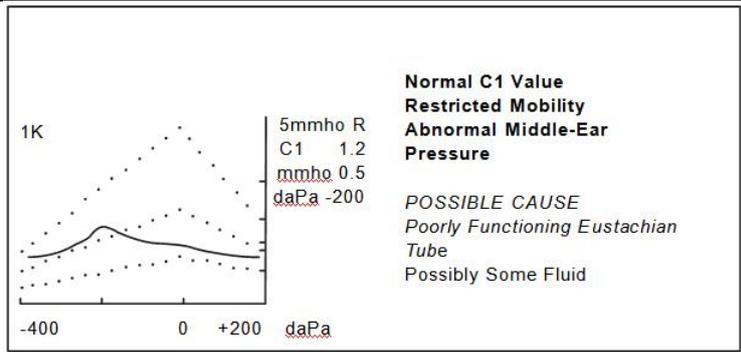

Figure 7: 1000 Hz Abnormal

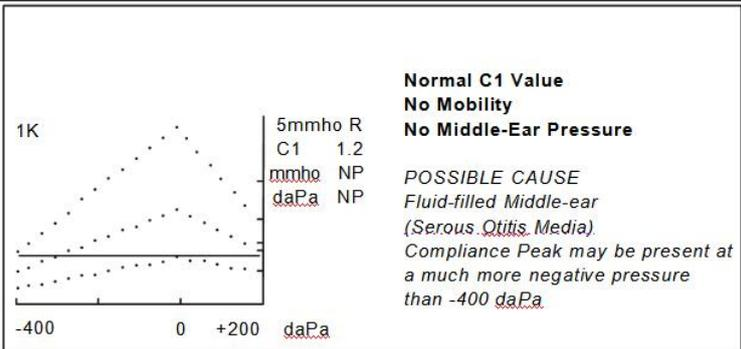

Figure 8: 1000 Hz Abnormal

COMPUTER INTERFACE

Introduction

WARNING



This equipment is intended to be connected to other equipment thus forming a Medical Electrical System. External equipment intended for connection to signal input, signal output or other connectors must comply with the relevant product standard e.g. IEC 60950-1 for IT equipment and the IEC 60601- series for medical electrical equipment. In addition, all such combinations – Medical Electrical Systems – must comply with the safety requirements stated in the general standard IEC 60601-1, (edition 3.1), clause 16. Any equipment not complying with the leakage current requirements in IEC 60601-1 must be kept outside the patient environment i.e. at least 1.5m from the patient support or must be supplied via a separation transformer to reduce the leakage currents. Any person who connects external equipment to signal input, signal output or other connectors has formed a Medical Electrical System and is therefore responsible for the system to comply with these requirements. If in doubt, contact a qualified medical technician or your local representative. When the instrument is connected to a PC, or other similar items, beware of not touching the PC and patient simultaneously. If in doubt, consult the technical service department or a local representative.

Operation

Press the  button to transfer test results stored in memory. During data transfer, the message **DATA TRANSFER** will appear on the LCD screen.

TRANSFERRING DURING NORMAL OPERATION

During normal testing operation, pressing the  button will transfer all stored test results sequentially.

TRANSFERRING FROM MEMORY PAGES

If the **PAGE** button is used to review individual test results stored in any of the 12 memory locations, the  button will transfer only the currently displayed stored test results. There is one exception to this rule: If the last (most recent) test result is displayed, the instrument assumes normal testing operation, and transfers all test results.

OTHER LCD SCREEN MESSAGES

INVALID SELECTION

This message appears if the  button is pushed during any of the following circumstances:

- During presentation of an audiometric tone
- During a tympanometry test
- During a reflex test
- During Printing

NO DATA AVAILABLE

This message appears if the  button is pressed and no results are stored.

NOT AVAILABLE

This message appears if the  button is pressed and the computer is not properly connected.

Data Transfer Program Mode

The Data Transfer Program mode is used to modify the GSI 39 USB interface configuration parameters to match the computer's USB Port settings.

Enter the Program mode by selecting the **PROGRAM** button. Move the cursor to **Data Xfer Config** and press the  button to enter the submenu.

The following screen appears the first time the Data Transfer Program mode is entered showing the factory default settings.

PROGRAM MODE - DATA TRANSFER

* 115.2 kBAUD	* NO PARITY + 8-BIT
57.6 kBAUD	ODD PARITY + 7-BIT
38.4 kBAUD	EVN PARITY + 7-BIT
19.2 kBAUD	SPC PARITY + 7-BIT
9600 BAUD	* XON/XOFF DISABLED
4800 BAUD	XON/XOFF ENABLED

These selections fall into three groups:

- Baud rate
- Parity and data bits
- Flow control

The default setting for each group has an asterisk (*) before it so that it is easy to scan the settings for each group.

Selecting default settings for any of the groups is achieved in the same manner as the Program mode. Use the ◀ or ▶ buttons to move the solid square cursor down or up to the setting that you wish to select. Press the M+ button. The word **SAVED** will appear in the lower right corner of the screen and the asterisk (*) will appear in front of the new setting.

To exit the Data Transfer Program submenu, move the cursor to the → press the  button. This will return to the Program mode which can be exited by selecting **PROGRAM**.

Computer Interface

INTERFACE CONFIGURATION

The configuration of the GSI 39 computer interface must be set to match the interface configuration of the computer. The GSI 39 defaults to 115 kBaud, no parity, 8 data bits, 2 stop bits and no communications flow control. The default settings for the baud rate, parity, number of data bits and flow control may be modified using the **Data Transfer Program Mode** explained earlier in this chapter.

CABLE CONNECTIONS

The computer interface provides a serial interface consisting of a USB connector.

GSI Suite

GSI Suite is a data management software program that is designed to store audiologic data and generate electronic copies of results for attaching to the medical record. Electronic formats include PDF, TIFF, JPEG, and XPS. It may be used as a standalone software package or as part of a networked solution when paired with OtoAccess or NOAH 4.

The GSI Suite Audiometric Data Management software is compatible with the GSI 39. Data transferred from the GSI 39 includes the following: tympanometric tracings and numeric data, reflex screening results and audiometric thresholds (air conduction, unmasked) depending on the configuration of the GSI 39. New test results obtained with GSI 39 instruments can only be transferred, viewed, and saved within GSI Suite if they are connected to a computer. Previously stored data may be viewed for evaluation or comparison without a connection to the GSI 39 instrument. Review the GSI Suite User manual for a complete description of the computer requirements, set up, installation and features of the software.

GSI SUITE INTERFACE CONFIGURATION

After configuring the GSI 39 computer interface and connecting the USB cable, install the GSI Suite as per the instructions provided with the GSI Suite software. Connect the USB cable between the computer and the GSI 39. Run the GSI Suite software and configure the software for connection with the GSI 39.

Suite Settings

Configure

General Tab

Connected Devices

-  Audiometry
-  Tympanometry



Restart GSI Suite to use the new configuration for the GSI 39.

NOTE: GSI Suite will communicate with one supported audiometer in addition to one supported tympanometer. The GSI 39 may be used as an audiometer, a tympanometer or both. The GSI Suite configuration is used to assign the GSI 39 as the audiometer or tympanometer.

UPLOADING DATA FROM THE GSI 39 TO GSI SUITE

1. If the application is not already running, double-click the GSI Suite icon on the desktop or select from the Windows Start menu to launch the program.



2. Select or enter the patient demographics.
 - a. If the patient has been seen before and has data in GSI Suite:

- i. Press the Lookup icon.
- ii. Scroll through the patient list (left column) or enter search criteria in the top field to sort the patient list.
- iii. Select the desired patient and then press the new session icon.

- b. For a new patient:

- i. Press the New Patient icon.
- ii. Enter the patient information (name, date of birth, ID).

3. Prior to testing the new patient, all data must be erased. Press the M-- on the GSI 39 to erase all data. Not doing this step may result in mixing test results from different sessions and/or patients.

4. Perform testing.

5. Select the Data Transfer button on the GSI 39. All data will be transferred to appropriate displays within GSI Suite.



NOTE: Data transfer can only be initiated from the GSI 39.

6. Press the Save icon on the GSI Suite toolbar to store the audiometric data to the session.

APPENDIX A - TECHNICAL DATA

Standards

IEC/EN 60601-1 Medical Electrical Equipment Requirements for Safety

CSA C22.2 No.601-1-M90

ANSI S3.39-1987 Aural Acoustic Impedance Admittance (Type 3)

IEC 60645-5 Aural Acoustic Impedance/ Admittance (Type 3)

ANSI S3.6-2004 Audiometers (Type 4)

IEC 60645-1 Pure Tone Audiometers (Type 4)

2004 Specifications for Audiometers (Type 4)

PTB Certificate No. 15.11-94/53 Pure Tone Audiometers (Type 4)

GL2005-00014 (ASHA 2005) Guidelines for Manual Pure-Tone

Threshold Audiometry

Protective Classification

This system is intended for continuous operation and has a protective classification of Class II

Class II Type B



APPENDIX B: SECIFICATIONS

Tympanometry Modes

Probe Tone:	226 Hz, ±2% 1000 Hz ±2%
Sound Pressure Level:	226 Hz: 85.5 dB SPL, ±2.0 dB, measured in a 2.0 cm ³ coupler 1000 Hz: 75 dB SPL, ±2.0 dB, measured in a 2.0 cm ³ coupler
Harmonic Distortion:	<3%
Admittance (Compliance) Range:	226 Hz: 0.0 to 1.5 cm ³ or 0.0 to 3.0 cm ³ 1000 Hz: 0.0 to 5.0 mmho and 0.0 to 10 mmho

NOTES:

1. The range is automatically selected based upon the amplitude of the compensated tympanogram.
2. The maximum uncompensated (ECV + tympanogram peak) admittance (compliance) range is 0 to 5.0 cm³.
3. ECV/cavity limits for initiating pressurization is 0.2 to 5.0 cm³. Compliance Accuracy: ±0.1 cm³ or ±5%, whichever is greater.

Pneumatic System

Pressure Range:	+200 to -400 daPa
	NOTES:
	1. daPa = 1.02 mmH ₂ O
	2. For 226 Hz probe tone, pressure sweeps to at least -100 daPa. To save test time, pressure sweep stops when tympanogram returns to baseline after -100 daPa.
	3. For 1000 Hz probe tone, pressure sweep does not stop until -400daPa.
	4. Full pressure sweep for 5 cm ³ from sea level to 7000 ft. altitude with no leak.
Pressure Accuracy:	±10 daPa or ±15%, whichever is greater
Rate of Sweep:	226 Hz: 600 daPa/sec except near tympanogram peak where sweep rate slows to 200 dapa/sec to provide better definition of peak compliance. 1000 Hz: 200 daPa/sec ±10 daPa/sec
Direction of Sweep:	Positive to negative
Tympanogram Test Time:	226 Hz: Approximately 1 second 1000 Hz: Approximately 3 seconds

NOTE: High compliance tympanograms will take somewhat longer.

Gradient: **226 Hz only:** Measurement of the tympanogram width taken at 50% of peak compliance.

Acoustic Reflex Stimuli

Frequencies: **226 Hz Probe Tone:** 500, 1000, 2000, and 4000 Hz for both ipsilateral and contralateral stimulation

1000 Hz Probe Tone: 500, 2000 and 4000 Hz for both ipsilateral and contralateral stimulation

Accuracy: ±3%

Total Harmonic Distortion: <5% for outputs less than 110 dBHL and <10% at 110 dBHL

Rise/Fall Time: 5 to 10 msec

Transducers

IPSILATERAL: GSI design

CONTRALATERAL: Single Audiovox Model SM-N insert phone (Version 2 and 3 only)

Output Levels:

IPSILATERAL: **For 226 Hz Probe Tone:**
500 and 4000 Hz: 80, 90, 100 db HL (Combo Probe design @ 4000 Hz has 80 and 90 db HL only)

1000 and 2000 Hz: 85, 95, 105 dB HL

For 1000 Hz Probe Tone:

500 and 4000 Hz: 80 and 90 dBHL

2000 Hz: 85 and 95 dBHL

CONTRALATERAL: For 226 Hz Probe Tone:

500, 1000, 2000, 4000 Hz: 90, 100, 110 dB HL

For 1000 Hz Probe Tone:

500, 2000 and 4000 Hz: 90 and 100 dB HL

NOTES:

- 226 Hz Probe Tone:** Ipsilateral stimuli are time multiplexed with probe tone (93 ms ON, 66 ms OFF).
1000 Hz Probe Tone: Ipsilateral stimuli are time multiplexed with probe tone (62 ms ON, 62 ms OFF).
- Contralateral stimuli are steady tones.
- Stimuli are presented at lowest level first. If there is no response, the intensity is increased by 10 dB until a response is detected or the maximum dB HL is reached.

4. Contralateral is available with Versions 2 and 3 only.

Pressure:	226 Hz Probe Tone: Reflex measures are set automatically to pressure at peak compliance with an offset of -20 daPa if peak pressure is negative and +20 daPa if peak pressure is positive. 1000 Hz Probe Tone: Reflex measures are taken at 0 daPa regardless of peak pressure.
Reflex Determination:	226 Hz: Compliance change of 0.05 cm ³ or greater. 1000 Hz: Compliance change of 0.1 mmho.
Reflex Test Time:	1 to 12 seconds depending upon the number of ipsilateral and/or contralateral test frequencies selected (4 maximum) and intensity required.

Probe LED Indicators

226 Hz Probe:

Steady yellow:	Occlusion
Blinking green:	Ready to start
Steady green:	Test in progress
Steady orange:	Leak in pressure
No Light:	Test is finished

Combo Probe:

Blinking green:	Ready to start
Steady green:	Test in progress
Steady orange:	Occlusion
Blinking orange:	Leak in pressure
No light:	Test is finished

Audiometry mode (Versions 3 and 4 only)

Frequencies:	125, 250, 500, 750, 1000, 1500, 2000, 3000, 4000, 6000, 8000 Hz
Accuracy:	±2%
Total Harmonic Distortion:	< 2.5% (125 to 3000 Hz measured acoustically at maximum dB HL; 4000 and 6000 Hz measured electrically)

TRANSDUCERS

Audiometric Headset:	Pair DD45 earphones with Type 51 cushions (10 ohms impedance) Headband force per ANSI S3.6 and IEC 645 (4.5 ±0.5)
Insert Earphones:	ER-3A (10 ohm impedance)

INTENSITY LEVELS

DD45 Headphones		Insert Phones	
125 Hz	-10 to 50 dB HL	125 Hz	-10 to 40 dB HL
500 to 4000 Hz	-10 to 90 dB HL	500 to 4000 Hz	-10 to 80 dB HL
6000 Hz	-10 to 85 dB HL	6000 Hz	-10 to 70 dB HL
250 and 8000 Hz	-10 to 70 dB HL	250 and 8000 Hz	-10 to 60 dB HL

NOTE: An additional +10 dB is available per frequency via the +10 dB button.

Accuracy:	125 to 4000 Hz ±3 dB 6000 and 8000 Hz ±5 dB
Step Size:	5 dB
Signal-to-Noise Ratio:	> 70 dB in 1/3 octave; less than -10 dB HL for levels less than 60 dB HL
Rise/Fall Time:	20 to 50 msec

TONE FORMAT

	Tone is normally off until the Present bar is depressed.
Continuous	Tone is steady when present bar is depressed
Pulsed	Tone is pulsed at 2.5/sec (i.e., 200 msec ON, 200 msec OFF)
FM (frequency modulated)	Tone is frequency modulated at a rate of 5 Hz, ±5%

Printer

Paper Roll Length:	Approximately 80 feet (960")
Tests/Roll:	
Versions 1 and 2:	Approximately 420 Tympanograms/Reflex or 210 people
Versions 3 and 4:	Approximately 230 tests or 115 people
Assumption:	2 Tympanograms/Reflex + 1 Audiogram per person
Speed:	Approximately 1 minute to print three screens: Tympanogram Tympanogram + reflex (4) Audiogram
External Printer:	Optional Deskjet color printer recognizing PCL3 or PCL3 GUI; 8-1/2" x 11" or A4 format

Power

Line Voltage:	100 - 240 VAC (±10%) NOTE: Desktop power supply.
Frequency Range:	47 - 63 Hz (±5%)
Power Consumption:	16 watts maximum while printing. Low voltage input for desktop power supplies 7 VDC, 3.0 A.
Display:	240 x 64 graphical, monochrome LCD

Environmental

Temperature

Operating:	59° to 104° F (15° to 40° C)
Warm-up time:	10 minutes for instruments stored at room temperature.
Storage/Shipping:	-93° to 149° F (-69° to 65° C)
Ambient Pressure:	98 kPa to 104 kPa
Humidity:	15% to 95%

Mechanical - Instrument

Instrument

Dimensions:	12.5" W x 14.5" D x 4.7" H 31.8 cm W x 36.8 cm D x 11.9 cm H
Weight:	5 lbs (2.3 kg) - unit and probe

Shipping Carton

Dimensions:	19.5" W x 22.5" D x 8.25" H 49.5 cm W x 57.2 cm D x 20.9 cm H
Weight:	13.1 lbs (6

APPENDIX C: GLOSSARY OF TERMS

Acoustic Reflex – Reflexive contraction of the stapedius muscle in response to loud sound.

Automated Audiometry (Auto HL) – Automated measurement of hearing that allows the listener to control the intensity with a hand switch.

Compliance Peak - The point of maximum mobility in a tympanogram, which indicates the degree of mobility within the middle-ear system.

Contralateral Acoustic Reflex – Acoustic reflex occurring in one ear as a result of stimulation of the same ear.

Ear Canal Volume - Volume measured between the tip of the probe and the tympanic membrane at the starting pressure for a tympanogram using a 226 Hz probe tone.

Ipsilateral Acoustic Reflex - The acoustic reflex elicited when the stimulus is presented to the same ear where the response is measured.

Normal Box - Range of pressure peak and compliance peak values associated with normal middle-ear function (-150 daPa to +100 daPa, 0.2 cm³ to 1.4 cm³ per ASHA, 32, Supl. 2, 1990, 17-24), only available on 226 Hz probe tone testing.

Pressure Peak - Pressure value where maximum mobility occurs in a tympanogram. This pressure value approximates the pressure within the middle-ear space.

Probe Tone – The pure tone that is held at a constant intensity level in the ear canal – assists in the measurement of middle ear function.

Screening Audiometry – Rapid assessment of the ability of individuals to hear acoustic signals across a frequency range at a fixed criterion intensity level; designed to identify those who require additional audiometric procedures.

Tympanogram – Graph of the middle ear immittance as a function of the amount of air pressure delivered to the ear canal.

Tympanometry – Procedure used in the assessment of middle ear function in which the immittance of the tympanic membrane and middle ear is measured as air pressure delivered to the ear canal is varied.

APPENDIX D: BIBLIOGRAPHY

American Speech-Language-Hearing Association (1990). "Guidelines for Screening for Hearing Impairment and Middle Ear Disorders". ASHA, 32 (Suppl.2), 17-24.

Criteria for Permissible Ambient Noise During Audiometric Testing (ANSI S3.1 - 1977).

de Jonge, R.R. (1986). "Normal Tympanometric Gradient: A Comparison of Three Methods". *Audiology*, 26, 299-308.

Koebse, K.A. & Margolis, R.H. (1986). "Tympanometric Gradient Measured from Normal Pre-School Children", *Audiology*, 25, 149-157.

Margolis, R.H. & Heller, J.W. (1987). "Screening Tympanometry: Criteria for Medical Referral". *Audiology*, 26, 197-208.

Margolis, R.H. & Shanks, J.E., "Tympanometry". In Katz, J. (Ed.), *Handbook of Clinical Audiology*, Ed.3., Baltimore: Williams & Wilkins, 1985.

Margolis, R. H., Bass-Ringdahl, S., Hands, W., Holte, L. and Zapala, D. A. (2003) "Tympanometry in Newborn Infants - 1 kHz Norms" *Journal of the American Academy of Audiology*, 14 (7), 383-392.

Michael, P.L. and Bienvenue, G.R., "Noise Attenuation Characteristics of Supra-Aural Audiometric Headsets using the Models MX41/AR and 51 Earphone Cushions," *J.Acoust.Soc.Am.*, 70(5), Nov.1981, 1235-1238.

Methods for Manual Pure-Tone Threshold Audiometry (ANSI S3.21 1978). Newby, H.A., *AUDIOLOGY* (4th Ed.). New Jersey: Prentice-Hall Inc. (1979).

Paradise, J.L., Smith, C.G., Bluestone, C.D. (1976). "Tympanometric Detection of Middle Ear Effusion in Infants and Young Children", *Pediatrics*, 58 (2), 198-210.

U.S. Department of Labor, Occupational Noise Exposure, CFR 1910.95, March 8, 1983.

APPENDIX E: ELECTROMAGNETIC COMPATIBILITY (EMC)

Portable and mobile RF communications equipment can affect the GSI 39. Install and operate the GSI 39 according to the EMC information presented in this chapter.

The GSI 39 has been tested for EMC emissions and immunity as a stand-alone device. Do not use the GSI 39 adjacent to or stacked with other electronic equipment. If adjacent or stacked use is necessary, the user should verify normal operation in the configuration.

The use of accessories, transducers and cables other than those specified, with the exception of servicing parts sold by GSI as replacement parts for internal components, may result in increased EMISSIONS or decreased IMMUNITY of the device.

Anyone connecting additional equipment is responsible for making sure the system complies with the IEC 60601-1-2 standard.

Cautions regarding EMC

Warning



This instrument is suitable in hospital environments except for near active HF surgical equipment and RF shielded rooms of systems for magnetic resonance imaging, where the intensity of electromagnetic disturbance is high.

Use of this instrument adjacent to or stacked with other equipment should be avoided because it could result in improper operation. If such use is necessary, this instrument and the other equipment should be observed to verify that they are operating normally.

Portable RF communications equipment (including peripherals such as antenna cables and external antennas) should be used no closer than 30 cm (12 inches) to any part of the GSI 39 instrument, including cables specified by the manufacturer. Otherwise, degradation of the performance of this equipment could result.

ESSENTIAL PERFORMANCE for this instrument is defined by the manufacturer as:

This instrument does not have an ESSENTIAL PERFORMANCE

Absence or loss of ESSENTIAL PERFORMANCE cannot lead to any unacceptable immediate risk

Final diagnosis shall always be based on clinical knowledge.

The GSI 39 is intended for use in the electromagnetic environment specified below. The customer or the user of the Instrument should assure that it is used in such an environment.

Guidance and manufacturer's declaration Electromagnetic emissions

The GSI 39 is intended for use in the electromagnetic environment specified below. The customer or the user of the GSI 39 should assure that it is used in such an environment. This instrument is in compliance with IEC60601-1-2:2014, emission class B group 1

Emissions Test	Compliance	Electromagnetic environment - guidance
RF emissions CISPR 11	Group 1	The GSI 39 uses RF energy only for its internal function. Therefore, its RF emissions are very low and are not likely to cause any interference in nearby electronic equipment.
RF emissions CISPR 11	Class B	The GSI 39 is suitable for use in all commercial, industrial, business, and residential environments.
Harmonic emissions IEC 61000-3-2	Class A	
Voltage fluctuations /flicker emissions IEC 61000-3-3	Complies	

Recommended separation distances between portable and mobile RF communications equipment

The GSI 39 is intended for use in an electromagnetic environment in which radiated RF disturbances are controlled. The customer or the user of the GSI 39 can help prevent electromagnetic interferences by maintaining a minimum distance between portable and mobile RF communications equipment (transmitters) and the GSI 39 as recommended below, according to the maximum output power of the communications equipment.

Rated Maximum output power of transmitter [W]	Separation distance according to frequency of transmitter [m]		
	150 kHz to 80 MHz $d = 1.17\sqrt{P}$	80 MHz to 800 MHz $d = 1.17\sqrt{P}$	800 MHz to 2.5 GHz $d = 2.23\sqrt{P}$
0.01	0.12	0.12	0.22
0.1	0.37	0.37	0.705
1	1.17	1.17	2.23
10	3.70	3.70	7.05
100	11.70	11.70	22.30

For transmitters rated at a maximum output power not listed above, the recommended separation distance d in meters (m) can be estimated using the equation applicable to the frequency of the transmitter, where P is the maximum output power rating of the transmitter in watts (W) according to the transmitter manufacturer.

Note 1 At 80 MHz and 800 MHz, the higher frequency range applies.

Note 2 These guidelines may not apply to all situations. Electromagnetic propagation is affected by absorption and reflection from structures, objects and people.

Guidance and Manufacturer’s Declaration Electromagnetic Immunity

Immunity Test	IEC 60601 Test level	Compliance	Electromagnetic Environment-Guidance
Electrostatic Discharge (ESD) IEC 61000-4-2	±8 kV contact ±15 kV air	±8 kV contact ±15 kV air	Floors should be wood, concrete or ceramic tile. If floors are covered with synthetic material, the relative humidity should be greater than 30%.
Electrical fast transient/burst IEC61000-4-4	±2 kV for power supply lines ±1 kV for input/output lines	±2 kV Not applicable	Mains power quality should be that of a typical commercial or residential environment.
Surge IEC 61000-4-5	± 0.5 & 1.0 kV line to line	± 0.5 & 1.0 kV	Mains power quality should be that of a typical commercial or residential environment.
Voltage dips, short interruptions and voltage variations on power supply lines IEC 61000-4-11	Dips: 100% reduction for 0.5 cycle (voltage shift @ 0, 45, 90, 135, 180, 225, 270 and 315 degrees) Dips: 100% reduction for 1 cycle (voltage shift @ zero phase crossing) Dips: 30% reduction for 500 ms (voltage shift @ zero phase crossing) Interruptions: 100% for 5000 ms (voltage shift @ zero phase crossing)	100% reduction for 0.5 cycle 100% reduction for 1 cycle 30% reduction for 500 ms 100% for 5000 ms	Mains power quality should be that of a typical commercial or residential environment. If the user of the <i>GSI 39</i> requires continued operation during power mains interruptions, it is recommended that the <i>GSI 39</i> be powered from an uninterruptable power supply or its battery.
Power frequency (50/60 Hz) IEC 61000-4-8	30 A/m	30 A/m	Power frequency magnetic fields should be at levels characteristic of a typical location in a typical commercial or residential environment.
Note: <i>UT</i> is the A.C. mains voltage prior to application of the test level.			

Immunity test	IEC / EN 60601 test level	Compliance level	Electromagnetic environment – guidance
<p>Conducted RF IEC / EN 61000-4-6</p> <p>Radiated RF IEC / EN 61000-4-3</p>	<p>3 Vrms 150 kHz to 80 MHz</p> <p>3 V/m 80 MHz to 2700 MHz</p>	<p>3 Vrms</p> <p>3 V/m</p>	<p>Portable and mobile RF communications equipment should be used no closer to any parts of the GSI 39, including cables, than the recommended separation distance calculated from the equation applicable to the frequency of the transmitter. Recommended separation distance</p> $d = 1,2\sqrt{P}$ $d = 1,2\sqrt{P}$ <p>80 MHz to 800 MHz</p> $d = 2,3\sqrt{P}$ <p>800 MHz to 2700 MHz</p> <p>Where P is the maximum output power rating of the transmitter in watts (W) according to the transmitter manufacturer and d is the recommended separation distance in meters (m).</p> <p>Field strengths from fixed RF transmitters, as determined by an electromagnetic site survey, (a) should be less than the compliance level in each frequency range (b) Interference may occur in the vicinity of equipment marked with the following symbol:</p> 
<p>NOTE 1 At 80 MHz and 800 MHz, the higher frequency range applies.</p> <p>NOTE 2 These guidelines may not apply in all situations. Electromagnetic propagation is affected by absorption and reflection from structures, objects and people.</p>			

^(a) Field strengths from fixed transmitters, such as base stations for radio (cellular/cordless) telephones and land mobile radios, amateur radio, AM and FM radio broadcast and TV broadcast cannot be predicted theoretically with accuracy. To assess the electromagnetic environment due to fixed RF transmitters, an electromagnetic site survey should be considered. If the measured field strength in the location in which the GSI 39 is used exceeds the applicable RF compliance level

above, the GSI 39 should be observed to verify normal operation, If abnormal performance is observed, additional measures may be necessary, such as reorienting or relocating the GSI 39.

^(b) Over the frequency range 150 kHz to 80 MHz, field strengths should be less than 3 V/m.

NOTICE: There are no deviations from the collateral standard and allowances uses

NOTICE: All necessary instruction for maintaining compliance with regard to EMC can be found in the general maintenance section in this instruction. No further steps required.

Use of accessories, transducers and cables other than those specified or provided by the manufacturer of this equipment could result in increased electromagnetic emissions or decreased electromagnetic immunity of this equipment and result in improper operation. To ensure compliance with the EMC requirements as specified in IEC 60601-1-2, it is essential to use only the following accessories:

Item	Manufacturer	Item #
GSI 39 LF Probe	Grason-Stadler	8512961
GSI 39 HF Probe	Grason-Stadler	8512959
IP30 insert earphone	RadioEar	8010910
DD45 headset	RadioEar	8010954

Conformance to the EMC requirements as specified in IEC 60601-1-2 is ensured if the cable types and cable lengths are as specified below:

Description	Length	Screened/Unscreened
GSI 39 LF Probe	2.6 m	screened
GSI 39 HF Probe	2.6 m	screened
IP30 insert earphone	1.8 m	screened
DD45 headset	2 m	unscreened
USB cable	2 m	unscreened

NOTICE: The use of the accessories, transducers and cables with medical equipment/system other than this equipment may result in increased emissions or decreased immunity of the medical equipment/system.